

AMERICA'S MOST COMPLETE LOCKER LINE®

SUPERIOR®

FULL LINE CATALOG

**2023 ONLINE
REVISION**



PROUDLY MADE IN AMERICA SINCE 1936





INDUSTRY INNOVATOR IN PRODUCT DESIGN

From Our Family To Yours



JR LIST
PRESIDENT

List Industries Inc. was founded in 1936 by Max. H. List, my grandfather, with the notion that customer satisfaction and product quality would be the basis for success.

His philosophy has been carried on for more than 80 years, through the efforts of my father, Herb List. Today we have become the industry leader. Looking back on the 40 years that I have been with List Industries, serving now as the company's President, I am proud to say that my grandfather's ingredients for success have given me the solid foundation needed to lead List Industries into the future.

Our journey began 80 years ago, when the first locker rolled out of the door of my grandfather's

factory in Chicago, IL, and it continues today, with the thousands of lockers manufactured daily in our Deerfield Beach, Apopka and Gainesville Florida locations. We are proud to be recognized as the industry leader, and as such, we remain committed to providing the highest quality lockers.

While the rest of the industry continues to flatter us by following our lead, our team continues working on new products and innovations to make sure that, as innovator and industry leader in product design and development, List Industries remains **America's Most Complete Locker Line[®]**.

Leading Innovation for over 80 years

Superior[®] Lockers, Cabinets, Shelving, & Gates, by List Industries Inc., are manufactured in our two modern, highly efficient, state-of-the-art facilities in Deerfield Beach and Apopka, Florida. We recently expanded capacity, making room for the installation of five million dollars' worth of computer-controlled fabricating, roll-forming and powder coat finishing systems to ensure consistent, quality workmanship.

Our top-of-the-line, automatic, numerically controlled, quick color change finishing system allows us to offer 24 standard designer powder coat applied colors with the highest quality and most durable paint finish in the industry.

From initial design to manufacture and finish, Superior[®] lockers are engineered using the most advanced computer technology to give you quality you can rely on.

The uniqueness of our Hollow-T framing system gives us the flexibility to custom design a locker to meet the specific requirements of your project. Our complete line of All-Star Sport Lockers offers you twelve standard



Turret Press

configurations per size, before adding options to further meet your needs All-Star Sport Lockers are the best steel sport locker available today. The addition of our Recruiter[™] wood and Phenolic Lockers insures a locker to meet your specific facility needs

This catalog depicts just a few of the endless design possibilities when choosing Superior fully-framed lockers; it also includes other product lines, all manufactured to the same high standards you have come to expect. We welcome the opportunity to work directly with you to custom design a locker room environment that is productive and attractive while remaining time and cost efficient.

Our team of designers, engineers and sales professionals is available to assist you every step of the way, from initial budget planning to final project closeout.

List Industries, Inc. leads the way in quality and customer service. From our corporate headquarters in Deerfield Beach, our three manufacturing plants in Florida, six strategically located regional distribution centers, seven regional sales offices located throughout the United States and our network of more than 300 authorized distributors nationwide, we provide the quality you demand, the timeliness you require and the service you deserve.





All Superior metal and plastic lockers are Greenguard Gold Certified.

Greenguard is an indoor air quality certification program for low emitting products and materials that evaluates over 75,000 chemicals, including volatile organic compounds, carcinogens, and reproductive toxins. Referenced in both the Collaborative for High Performance Schools (CHPS) and the Leadership for



Energy and Environment Design (LEED) Building Rating System, Greenguard Gold Certification establishes strict chemical emission standards for products intended for use in environments where children and others work, play or reside.



GALVANITE™ CORROSION RESISTANT SHEET STEEL

Ideal for use in high humidity areas, outdoor locations, near shower, pool areas and food industry facilities

GALVANITE™, is List Industries' trade marked name for lockers and cabinets manufactured with galvaneal sheet steel components and finished with an electrostatically applied high-grade powder coat finish. Galvanite and powder coat offer exceptional double protection against corrosion, even under the most adverse conditions. Tests indicate that galvaneal increases the estimated life cycle threefold.

What Is Galvaneal?

Galvaneal is the result of the combined processes of galvanizing (hot-dipped zinc coating) and annealing (heat treatment). Galvaneal does not flake off its galvanized coating when formed, stamped, and bent. The very fine matte finish acts like a primer that easily adheres to paint. These characteristics make galvanealed sheet steel ideal for steel lockers in high humidity, corrosion prone areas.

GALVANNEAL SHEET STEEL

with our powder coat finish after a 336 hour salt spray test.



COMMON COLD ROLLED SHEET STEEL

with a 1 mil dry film build paint thickness after a 336 hour salt spray test.

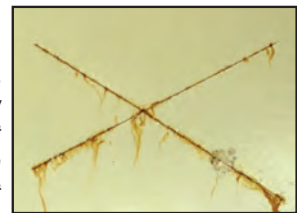

TABLE OF CONTENTS

PRODUCTS	PAGE
Fully-Framed All-Welded Production Lockers	4
Unibody All-Welded Production Lockers.....	26
Welded Cubbies	32
Knock-Down (KD) Production Lockers	34
Benches And Pedestals	46
Locks	47
Cubix Lockers	49
Backpack/Laptop lockers	50
Cell Phone lockers.....	51
Bulk Storage Lockers (BSL).....	52
Parcel Lockers	54
Portable Gates	55
Wood Lockers	56
AquaMax™ HDPE Solid Plastic Lockers.....	62
VersaMax™ Phenolic Lockers	64
HiTech® Clip Shelving	66
DuraTech™ PassThru Shelving	70
Rivetwell™ Boltless Shelving	72
400-800 Series KD Cabinets	80
DuraTough™ All Welded Cabinets	84
Color Options.....	88-89
Quick-Ship Program	90

Made in America Since 1936



Deerfield Beach, Florida Headquarters



SUPERIOR
AMERICA'S MOST COMPLETE LOCKER LINE

FULLY-FRAMED ALL-WELDED LOCKERS

CONTINUOUS 16 GAUGE FLAT TOP

Optional slope top available

STANDARD SAFETY MINDED SELF-CLOSING TOP HINGED DOORS

Continuous hinge rods safely concealed.
Standard on doors 12" high and under.

TWO TONE COLOR OPTION AT NO ADDITIONAL CHARGE



GALVANNEAL shelves and bottom for added corrosion resistance.

1/2" MESH VENTILATED SIDES

13 gauge flattened expanded metal protected and fully-framed by our unique structured roll formed Hollow-T framing system. Fully framed solid sides are optional

FULL HEIGHT DOOR STIFFENER

Standard for all Doors 20" high and above that are over 15" wide and all marquis lockers. Available as an option on other doors.

14 GAUGE GALVANNEAL channels both front and back provide corrosion resistance at locker bottom



WHAT A DIFFERENCE

Our 13 gauge 3-1/2" 7-Knuckle hinge vs the industry's standard 2" KD locker hinge

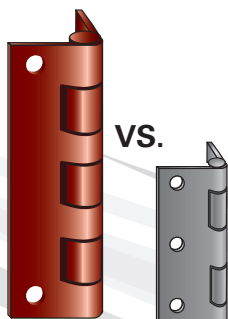

THE INDUSTRY'S, BEST LATCH

Our rugged 11 gauge MIG welded latch hook with large riveted bumper vs the industry common KD style latch

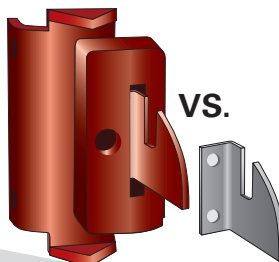

SUPERIOR HINGES

SUPERIOR LATCHES

THE STRUCTURAL INTEGRITY OF OUR FULLY-FRAMED ALL-WELDED LOCKERS

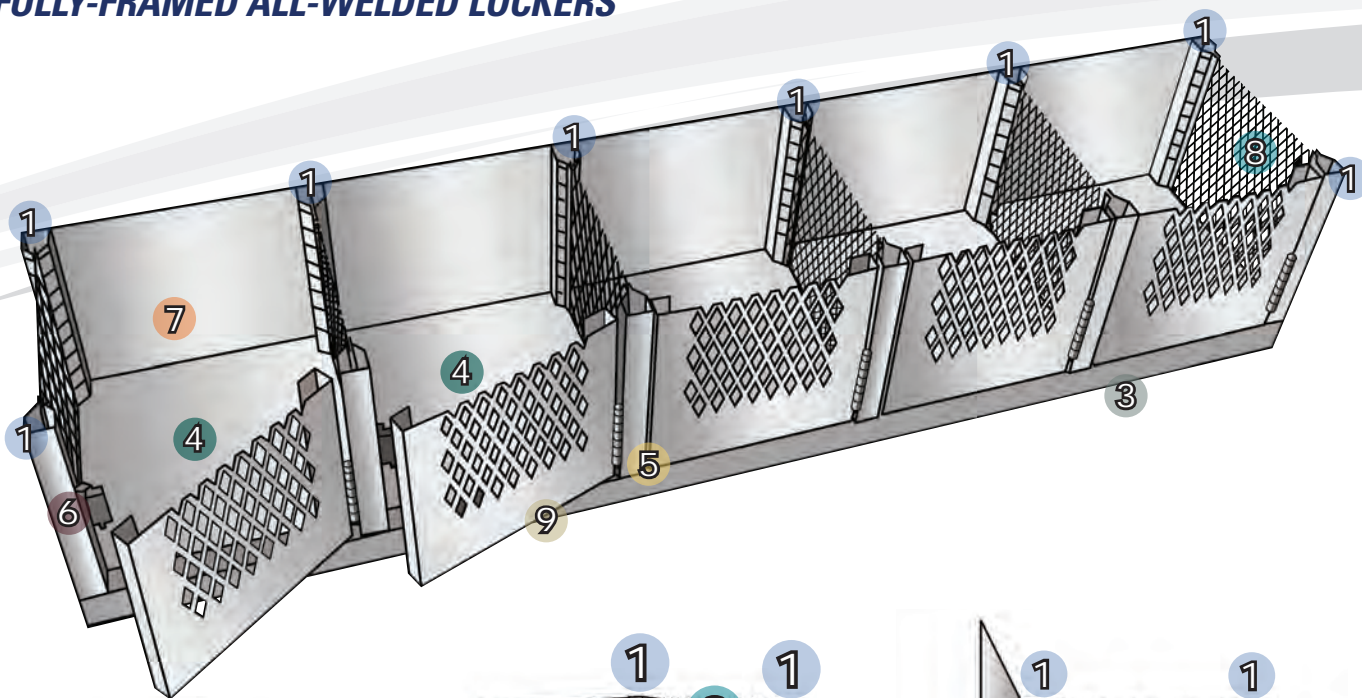

6-Bend Structural roll-formed vertical framing member

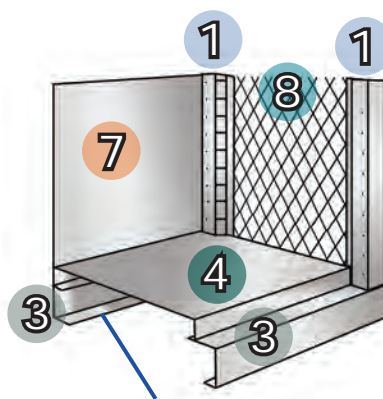

14 gauge cold rolled horizontal channel base frame members run continuous across full width of multiple column unit at front and back.

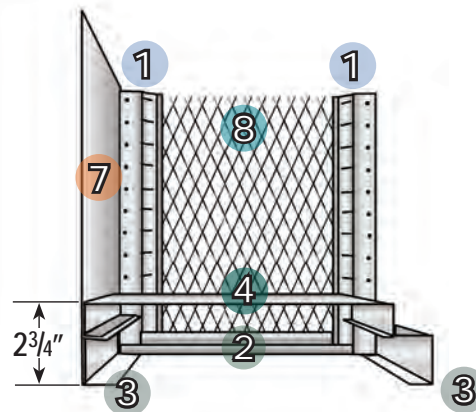

SUPERIOR® fully-framed locker bottoms are a full 2-3/4" above finished floor eliminating the need for and additional base

1 Structural roll formed 16 gauge Hollow-T tubular frame members run top to bottom at all four corners of each locker column.

2 16 gauge double channel horizontal frame members run front to back at top and bottom.

3 14 gauge galvaneal horizontal channel base frame members, front and back, run continuous across the full width of a multiple column locker unit. Channels are galvaneal for added corrosion resistance

4 16 gauge galvaneal bottom & intermediate shelves are corrosion resistant and locked into frame at all four corners and securely MIG welded.

5 Heavy-duty 13 gauge 7 knuckle 3-1/2" hinges are the industry's strongest hinge

6 11 gauge MIG welded latch hooks with large riveted-on bumper, far exceeding industries standards

7 18 gauge solid back is continuous across multiple locker columns

8 13 gauge 1/2" diamond pattern, flattened expanded metal sides are enclosed on all four sides by the structural Hollow-T framing system

9 14 gauge doors are available in diamond perforated, solid, louvered or mini louvered

**SUPERIOR® DESIGN AND ENGINEERING
CREATE THE INDUSTRIES STRONGEST AND SAFEST LOCKER**



**STRUCTURALLY
FULLY-FRAMED**



**27%
LESS
STEEL**

**ANGLE FRAME
CONSTRUCTION
WITH 3/4"
EXPANDED METAL**



**23%
LESS
STEEL**

**UNIBODY
CONSTRUCTION
WITH SIDE AND
FRAME OF ONE PIECE**



**50%
LESS
STEEL**

**KD
CONSTRUCTION
WITH INDIVIDUAL
COMPONENTS**

SUPERIOR'S UNIQUE STRUCTURAL HOLLOW-T SIDE PANEL FRAMES are the strongest, safest and most rigid structure in the industry utilizing welded vertical Hollow-T framing members and horizontal channels to enclose expanded metal on all four sides. Superior's Hollow-T side panels have substantially more steel than all competitors.

**SUPERIOR® FULLY-FRAMED
LOCKER BOTTOM**



**LOCKER SIDES EXTEND TO FLOOR/
BASE FOR MAXIMUM STRENGTH AND
STABILITY OF LOCKER INSTALLATION**

**COMPETITOR
LOCKER BOTTOM**



NO REINFORCEMENT!

SAFEMESH 84™

THE INDUSTRY'S STRONGEST AND SAFEST EXPANDED METAL



COMPETITOR

3/4" MESH
13 GAUGE FLATTENED
EXPANDED METAL



SUPERIOR

1/2" MESH
13 GAUGE FLATTENED
EXPANDED METAL

STRENGTH: 84% more steel ensures a stronger more rigid unit than 3/4" mesh

SAFETY 1/2" mesh design keeps fingers out

SECURITY: Reduces risk of loss, theft and content damage



SUPERIOR® LOCKERS LOCK BARS ARE INSTALLED AFTER THE DOORS ARE PAINTED



SUPERIOR® LOCK CHANNEL

ROLL FORMED G90 HOT DIPPED GALVANIZED LOCK BARS are installed after the doors are painted to ensure complete paint coverage, corrosion resistance and smoother lock bar operation. Others use standard steel and/or install the lock channel before paint trapping moisture in, preventing proper paint coverage leading to corrosion problems.

Dupont® Supertough® nylon latches are made in the USA and are installed after paint to insure a lifetime of superior performance. Use of lower quality plastics and/or installing before paint can cause brittleness and poor performance.

CUSTOMIZE TO MEET YOUR NEEDS

- ✓ No Costly Engineering
- ✓ No Added Lead-Time
- ✓ No Set-Up Charges
- ✓ No Problem!

Our unique Hollow-T framing system allows you to mix and match doors to create the perfect storage solution.

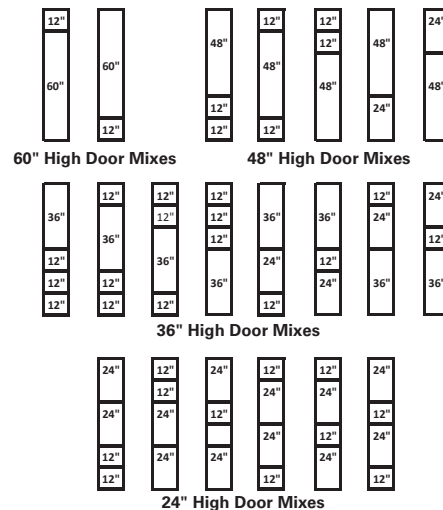

SUPERIOR
AMERICA'S MOST COMPLETE LOCKER LINE

The Sport Locker That Sets The Standard All Others Must Follow...



Player Tested and Game Ready!

The All-Star sport locker's quality, functionality and durability raised the bar for sport lockers. All-Star lockers feature our exclusive Hollow-T framing system, with 1/2" 13 gauge flattened expanded metal sides for maximum ventilation, safety and rigidity. Interlocking body components creates a functional yet sturdy sports locker, guaranteed to last a lifetime. The versatility of our Hollow-T framing system allows you to customize a locker to your specific requirements.

- All MIG welded construction
- Powder coated and baked body construction
- 16 gauge Hollow-T tubular sections & channel frame.
- 14 gauge cold rolled steel locker base
- 13 gauge cold rolled steel 1/2" flattened expanded metal vertical side panels .
- Standard hat shelf and 2 single prong wall hooks, 1 double prong ceiling hook.



All-Star Lockers feature **SafeMesh84™**, the industry's strongest and safest expanded metal.



See page 88 for color selections

OUR MOST POPULAR CONFIGURATION
Shown here with optional 12" wide security box, stainless steel coat rod and foot locker/seat. Both security box sides are solid.



Configurations Designed to Meet Your Locker Needs

Upper Options



Open top shelf with under hang hooks



Upper wallet security box with stainless steel coat rod



12" wide security box with stainless steel coat rod



Full width security box with stainless steel coat rod



Wallet and 12" wide Security boxes have single-point thru-the-door projecting Antimicrobial finger pulls for protection against bacteria.

Lower Options



Open lower



Reinforced seat



Foot locker with reinforced seat



Underside of foot locker seat is reinforced to support today's athlete

Additional Options



Shoulder pad rack



Shoulder pad rack with helmet support



2" or 3" Padded seat cushion

A POPULAR CONFIGURATION

Shown here with full width security compartment, stainless steel coat rod and lower shelf/seat. Both security compartment sides are ventilated. See back cover for color selections.

LOCKER SIZES

Widths 18", 24", 30", 33", 36"
 Depths 12", 16", 18", 22"
 Nominal Heights 60", 72", 84"

Note:

Actual locker column height is 2-3/4" over nominal column heights shown for 60" and 72" models. 84" high models will be 84" actual.

• All-Star lockers will ship in multiple column units up to 60" wide to meet individual jobsite conditions.

FEATURES

BODY CONSTRUCTION: All MIG welded construction.

FRAME: 16 gauge Hollow-T tubular sections running top-to-bottom at all 4 corners of each locker column. 16 gauge double channel run front to back at both the top and bottom of each locker side

VERTICAL SIDE PANELS: 13 gauge cold rolled steel 1/2" flattened expanded metal framed by Hollow-T tubular framing system.

LOCKER BASE: 14 gauge cold rolled steel channel running full width of welded locker unit at both front and back

OPTIONAL LOWER SEAT/SHELF: Shall be 16 gauge 1" with a reinforcing bar welded to lower front for rigidity.

OPTIONAL FOOT LOCKER: 14 gauge cold rolled steel with Security-Plus ventilation, seat opens for storage.

STANDARD: hat shelf and two single prong wall hooks, one double prong ceiling hook.

ATHLETIC TEAM FULLY-FRAMED ALL-WELDED LOCKERS

Designed With Today's Athlete In Mind

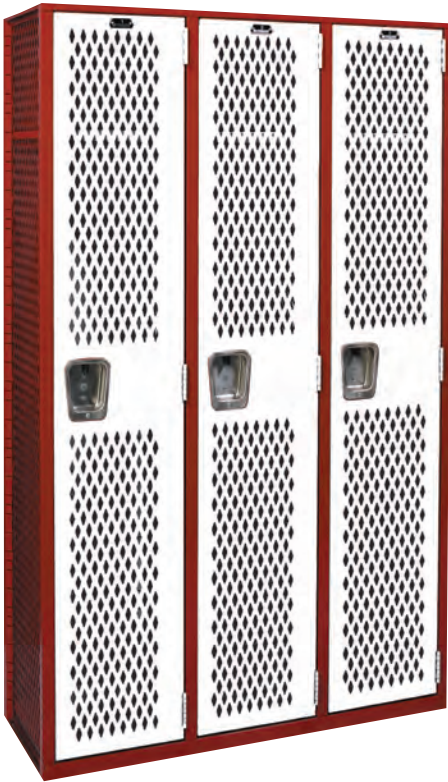

VARSITY SINGLE TIER

Highly recommended for varsity team rooms, engineered to withstand extreme abuse.



JR. VARSITY DOUBLE TIER

Ideal when budget and/or space are limited. Double tier lockers can be used in team rooms as well as in P.E. rooms.



INTRAMURAL TRIPLE TIER

Ideal when space and/or funds are limited. The opening height allows clothing to hang on hooks allowing better ventilation.



STANDARD ATHLETIC TEAM FULLY-FRAMED ALL-WELDED LOCKERS

VARSITY SINGLE TIER

Widths: 9", 12", 15", 18", 24"
 Depths: 12", 16", 18", 22"
 Opening Heights 36", 48", 60", 72"
 Nominal Column Heights: 36", 48", 60", 72"

JR VARSITY DOUBLE TIER

Widths 9", 12", 15", 18", 24"
 Depths 12", 16", 18", 22"
 Opening Heights 24", 30", 36"
 Nominal Column Heights 48", 60", 72"

INTRAMURAL TRIPLE TIER

Widths 9", 12", 15", 18", 24"
 Depths 12", 16", 18", 22"
 Opening Heights 20", 24"
 Nominal Column Heights 60", 72"

Notes:

- Actual locker column height for fully-framed all-welded only, is 2-3/4" over nominal column heights shown
- All welded lockers will ship in multiple column units up to 60" wide to meet individual job site conditions
- 18" & 24" Wide All-Welded Lockers are only available in Premier Series (include full height door stiffener)

ATHLETIC TEAM FULLY-FRAMED ALL-WELDED LOCKERS

PREMIER SERIES TEAM LOCKERS



STANDARD DOOR STIFFENER FOR 18" AND 24" WIDE



3-POINT HIGH SECURITY TURN HANDLE

is available for Varsity, Jr. Varsity and Intramural Team lockers. Not available in 9" wide lockers.

STANDARD



Deep-drawn 304 stainless steel recessed handle with multi-point gravity lift-type latching includes our antimicrobial recessed handle finger lift cover for protection against bacteria

STANDARD

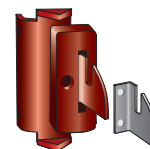

Our rugged 11 gauge MIG welded latch hook with large riveted on bumper vs. common K.D. locker style latch hook

STANDARD

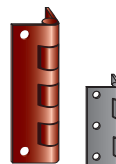

Our heavy-duty 13 gauge 7-knuckle 3-1/2" hinge vs. common 2" K.D. locker style hinge



PREMIER SERIES TEAM LOCKERS

Includes a 3" wide 18 gauge full height door stiffener spot welded to the inner door face and MIG welded to the hinge side as well as to the top and bottom door flanges providing a rigid torque-free door. A 1-1/2" wide stiffener will be furnished for 9" wide Premier Series Team locker doors and optional 12" wide Premier Series turn-handle style doors.

FEATURES

BODY CONSTRUCTION: Fully-framed all-welded Hollow-T construction, 13 gauge 1/2" fully-framed flattened expanded metal sides, 16 gauge continuous top, 18 gauge solid back, 16 gauge galvaneal bottom

DOORS: 14 gauge diamond perforated doors are standard. Plain, louvered and Security-Plus door styles are available

HANDLE: Deep-drawn seamless stainless steel recessed handle. Optional projecting 3-point turn-handle is available.

LATCHING: 11 gauge latch hooks with riveted on bumper MIG welded to Hollow-T frame. Gravity lift-type multi-point spring loaded latching:

- 3-point latching for openings 48" high and higher
- 2-point latching for openings 20" high thru 36" high

Lock Bars are fabricated from G90 galvanized steel and are installed into the door after paint.

HINGES: Heavy-duty 13 gauge 7-knuckle 3-1/2" hinges:

- 3-hinges per opening 48" high and higher
- 2-hinges per opening 20" high thru 36" high

SHELVES: 16 gauge galvaneal hat shelf for Varsity openings 60" and 72" high, 16 gauge galvaneal intermediate shelves

HOOKS: 2-single hooks and 1-double hook is standard. 1-double hook only for triple tier and 1-double and 1-single hook for 9" wide openings 30" and higher

WARRANTY: Lifetime

SIZES: See size chart on Page 10

FOR MORE INFO GO TO LISTINDUSTRIES.COM

SUPERIOR
AMERICA'S MOST COMPLETE LOCKER LINE

P.E. SERIES FULLY-FRAMED ALL-WELDED LOCKERS

A Coaches Dream Locker Room

Heavy gauge, fully-framed, all-welded construction combined with modern features and the Hollow-T design flexibility let you transform your locker room into an accessible environment, maximizing space and improving supervision without sacrificing

aesthetic appeal. Innovative solutions, like our Gym Class 9E and Gym Class 8D locker configurations, are the result of partnering and listening to coaches and P.E. instructors for more than 80 years.

Shown with optional padlock strike plates

Doors 12" high and under are standard with top hinge. Side hinge doors are available as an option

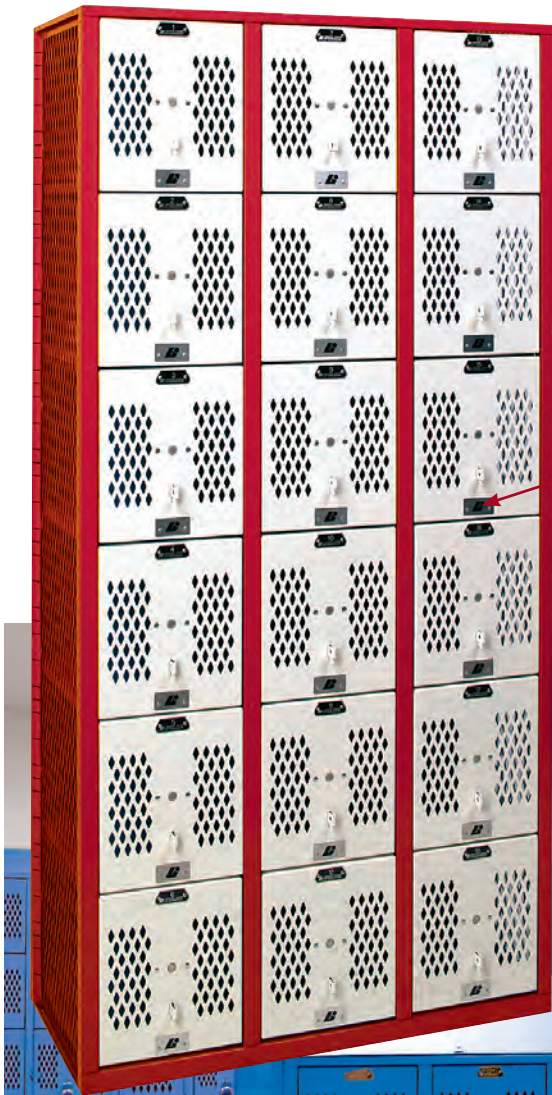

Superior Fit to Your Space Needs

P.E. SERIES FULLY-FRAMED ALL-WELDED LOCKERS

Choose From Unlimited Combinations to Meet Your Specific Locker Needs

Widths for all gym locker openings 12", 15", 18"
 Depths for all gym locker openings 12", 16", 18", 22"

TIER		OPENING HEIGHTS	NOMINAL COLUMN HEIGHTS
4 TIER TO 9 TIER	Four Tier	8", 9", 12", 15", 18"	32", 36", 48", 60", 72"
	Five Tier	12", (4) 15" & (1) 12"	60", 72"
	Six Tier	8", 10", 12"	48", 60", 72"
	Seven Tier	(6) 10" & (1) 12"	72"
	Eight Tier	8", 9"	64", 72"
	Nine Tier	8"	72"



Upgrade to Premier Series P.E. lockers which include a 3" wide 18 gauge full height door stiffener and are side hinged

OPTIONAL:



Seamless 304 stainless steel recessed handle is available. Doors will be side hinged and will use our Marquis style single-point thru-the-handle latching

STANDARD



Projecting spring loaded latch is standard on top hinged gym doors only



Top hinged doors with concealed hinge rod are standard for 12" high and under

STANDARD



Single-point thru-the-door projecting Antimicrobial finger pull for protection against bacteria with padlock hasp is standard for side hinged doors



Side hinged doors are standard for 15" and 18" high, optional for doors 12" high and under



FEATURES

BODY CONSTRUCTION: Fully-framed all-welded Hollow-T construction, 13 gauge 1/2" fully-framed flattened expanded metal sides, 16 gauge continuous top, 18 gauge solid back, 16 gauge galvaneal bottom

DOORS: 14 gauge diamond perforated doors are standard. Louvered, Security-Plus and plain door styles are available. Doors 12" high and under are standard with top hinge. Doors 15" and 18" high are standard with side hinge.

HANDLE/LATCHING: Top hinge doors have a projecting spring loaded heavy-duty latch/handle with integral padlock lug. Side hinge doors have a single-point thru-the-door projecting finger pull handle with padlock hasp. Optional deep-drawn seamless stainless steel recessed handle is available for side hinged gym doors (10" high and higher) and will utilize our Marquis style thru-the-handle single-point no moving parts latching and include two 13 gauge 7-knuckle 3-1/2" hinges

HINGES: Top hinge doors use a concealed 3/16" continuous rod. Side hinge doors use two heavy-duty 13 gauge 7-knuckle 3-1/2" hinges. Optional side hinged doors 8" and 9" high will have special hinges

HOOKS: None

SHELVES: 16 gauge galvaneal intermediate shelves

FOR MORE INFO GO TO LISTINDUSTRIES.COM

P.E. SERIES FULLY-FRAMED ALL-WELDED LOCKERS

**A Cost Effective Game Changer
MAXIMIZE SPACE WITH THE 9E UNIT (6:1 RATIO)**

This unit is a favorite among architects, coaches and physical education instructors. Superior Class 9E lockers accommodate 12 students in a compact three linear feet of space, replacing the typical "626" combination with the

popular 6:1 Ratio. Lockers where PE clothing is stored are a full 18" wide x 8" high. Wardrobe lockers for hanging school clothing are 9" wide x 48" high. Standard Class 9E unit size is 36-3/8" wide x (12", 16", 18", 22") deep x 74-3/4" high actual.



No. 8D
(5:1 Ratio)

Doors are shown with optional padlock strike plates which protect finish from being marred by padlock.

No. 9E
(6:1 Ratio)



**THE EFFICIENT 8D UNIT
(5:1 RATIO)**

Superior Class 8D lockers are designed with the same premise as its big brother, the Class 9E. We have engineered the finest 5:1 ratio P.E. unit in the locker industry utilizing the same floor space as a standard "525" configuration. This locker is a nominal 64" high (66-3/4" actual height) as

opposed to 60". Lockers where PE clothing is stored are a full 18" wide x 8" high and the wardrobe lockers are 9" wide x 48" high. Standard Class 8D unit size is 36-3/8" wide x (12", 16", 18", 22") deep x 66-3/4" high actual

Typical Locker VS. Superior 9E & 8D Lockers



12" wide x 12" high



18" wide x 8" high

- Maximizes ventilation for clothing and shoes
- Increases shelf space by 50%
- Adds 12" in height to wardrobe opening
- One gym locker at unit bottom in lieu of two
- 3 latch points & 3 hinges per wardrobe door instead of 2

P.E. SERIES FULLY-FRAMED ALL-WELDED LOCKERS



No. 61 (6:1 Ratio)

No. 6A (7:1 Ratio)

No. A6A (4:1 Ratio)

No. 51 (5:1 Ratio)

No. 525 (5:1 Ratio)

TYPICAL SUPERIOR P.E. LOCKER COMBINATIONS

The design flexibility of our all-welded athletic lockers allows us to mix and match wardrobe lockers with box lockers to meet any configuration and/or ratio your facility may demand. Please feel free to contact our Sales Manager at 1-800-776-1342. He will help you create an environment which will be both esthetically pleasing and functional.

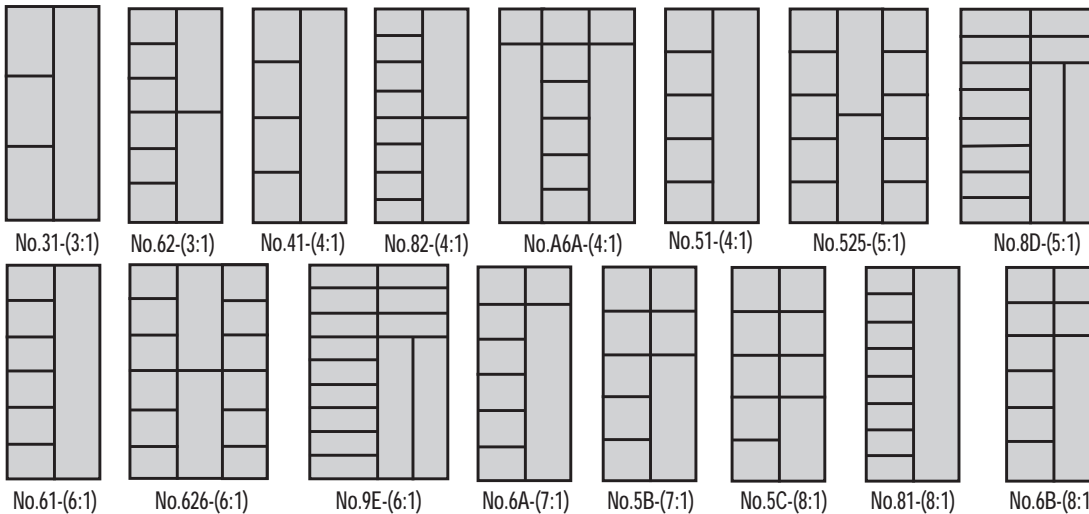

FOR MORE INFO GO TO
LISTINDUSTRIES.COM

ALL-WELDED FULLY-FRAMED ATHLETIC LOCKERS

MARQUIS CHAMPION LOCKERS

With more than 30 years of experience manufacturing single-point lockers, Superior Marquis Champion lockers are manufactured to the industry's highest standards by incorporating our Hollow-T framing system, interlocking body

components, maintenance-free single-point latching mechanism, reinforced doors and the industry's strongest hinges to deliver a lifetime of satisfaction.

**A Winner From Top To Bottom
Versatility, Durability and a Lifetime Warranty**



Single Tier
3-Wide

Style No.626-(6:1)



See page 88 for
color selections

ALL-WELDED FULLY-FRAMED ATHLETIC LOCKERS

This is the most rugged athletic locker available today.



Single Tier
3-Wide



MARQUIS CLASSIC DOOR LINER

18 gauge full width door liner covers back of recessed handle. Built-in lock attaches to both door liner and recessed handle for maximum security and rigidity.

STANDARD



Deep-drawn 304 stainless steel recessed handle with single-point latching

STANDARD



11 gauge single-point latch MIG welded to Hollow-T frame

STANDARD

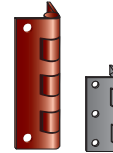

Heavy-duty 13 gauge 7-knuckle 3-1/2" hinge vs. a common 2" K.D. locker style hinge

MARQUIS CHAMPION STANDARD - DOOR STIFFENER

Includes a 3" wide 18 gauge full height door stiffener spot welded to the inner door face and MIG welded to the hinge side as well as to the top and bottom door flanges providing a rigid torque-free door. A 1-1/2" wide stiffener will be furnished for 9" wide Marquis doors.



FEATURES

BODY CONSTRUCTION: Fully-framed all-welded Hollow-T construction, 13 gauge 1/2" fully-framed flattened expanded metal sides, 16 gauge continuous top, 18 gauge solid back, 16 gauge galvaneal bottom

DOORS: 14 gauge diamond perforated doors with a full height 3" wide 18 gauge door stiffener are standard. Plain, louvered and Security-Plus door styles are available. All doors are side hinged

HANDLE: Deep-drawn single-point seamless stainless steel recessed handle

LATCHING: Single-point maintenance-free quiet latching with 11 gauge MIG welded latch with pry resistant lug

HINGES: Heavy-duty 13 gauge 7-knuckle 3-1/2" hinges:

- 3-hinges per opening 48" high and higher
- 2-hinges per opening 36" high and under

HOOKS: 2-single hooks and 1-double hook is standard. 1-double hook only for triple tier and 1-double and 1-single hook for 9" wide openings 30" and higher. No hooks for openings 18" high and under

SHELVES: 16 gauge galvaneal hat shelf for single tier openings 60" and 72" high, 16 gauge galvaneal intermediate shelves

FOR MORE INFO GO TO
LISTINDUSTRIES.COM

FULLY-FRAMED ALL-WELDED CORRIDOR LOCKERS

GRADUATE CORRIDOR LOCKERS

With the addition of solid sides and louvered doors, the industry's best athletic locker is perfect for corridor applications when maximum strength, durability and longevity are important. Graduate lockers include our lifetime warranty, which is standard on all fully-framed all-welded lockers.

The use of our exclusive Hollow-T framing system together with galvanneal bottom, intermediate and hat shelves (where applicable) achieves a degree of excellence previously reserved for high abuse athletic room. Upgrade to our Graduate Premier and you get our full height door stiffener creating a rigid torque-free door.

*Top Of The Class
Proven Durability Every Semester*



Single Tier
3-Wide



Triple Tier
3-Wide



See page 88 for
color selections

FULLY-FRAMED ALL-WELDED CORRIDOR LOCKERS
GRADUATE CORRIDOR LOCKERS



Double Tier
3-Wide

STANDARD  **ANTIMICROBIAL PROTECTION**



Deep-drawn 304 stainless steel recessed handle with multi-point gravity lift-type latching includes our Antimicrobial Recessed Handle Finger Lift Cover for protection against bacteria

STANDARD

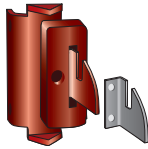

11 gauge latch hooks with riveted on bumper MIG welded to Hollow-T frame

STANDARD

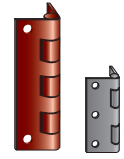

Heavy-duty 13 gauge 7-knuckle 3-1/2" hinge vs. a common 2" K.D. locker style hinge



PREMIER SERIES GRADUATE LOCKERS include a 3" wide 18 gauge full height door stiffener spot welded to the inner door face and MIG welded to the hinge side as well as to the top and bottom door flanges providing a rigid torque-free door. A 1-1/2" wide stiffener will be furnished for 9" wide Premier Series doors. 18" and 24" wide doors are only available in Premier Series.



FEATURES

BODY CONSTRUCTION: Fully-framed all-welded Hollow-T construction, 18 gauge fully-framed solid sides, 16 gauge continuous top, 18 gauge solid back, 16 gauge galvaneal bottom

DOORS: 14 gauge louvered doors are standard Plain, Security-Plus, Safety-View and diamond perforated door styles are available

HANDLE: Deep-drawn seamless stainless steel recessed handle

LATCHING: 11 gauge latch hooks with riveted on bumper MIG welded to Hollow-T frame. Gravity lift-type multi-point spring loaded latching:

- 3-point latching for openings 48" high and higher
- 2-point latching for openings 20" high thru 36" high

Lock Bars are fabricated from G90 galvanized steel and are installed into the door after paint.

HINGES: Heavy-duty 13 gauge 7-knuckle 3-1/2" hinges:

- 3-hinges per opening 48" high and higher
- 2-hinges per opening 20" high thru 36" high

SHELVES: 16 gauge galvaneal hat shelf for single tier openings 60" and 72" high, galvaneal intermediate shelves

HOOKS: 2-single hooks and 1-double hook is standard. 1-double hook only for triple tier and 1-double and 1-single hook for 9" wide openings 30" and higher

FOR MORE INFO GO TO
LISTINDUSTRIES.COM

FULLY-FRAMED ALL-WELDED CORRIDOR LOCKERS

MARQUIS® PROTECTOR

This is the most durable and quiet corridor locker in the industry, constructed using our fully-framed, all-welded Hollow-T framing system.

If you are looking for quiet, maintenance-free corridor lockers to last the life of your facility, our Marquis® Protector is your best choice, backed up in writing by our lifetime warranty.



Double Tier
3-Wide

Triple Tier
3-Wide



See back cover for
color selections

FULLY-FRAMED ALL-WELDED CORRIDOR LOCKERS

MARQUIS® PROTECTOR



Single Tier
3-Wide



STANDARD



Deep-drawn 304 stainless steel recessed handle with single-point latching

STANDARD



11 gauge single-point latch MIG welded to Hollow-T frame

STANDARD

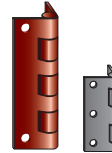

Heavy-duty 13 gauge 7-knuckle 3-1/2" hinge vs. a common 2" K.D. locker style hinge

STANDARD



Include a 3" wide 18 gauge full height door stiffener spot welded to the inner door face and MIG welded to the hinge side as well as to the top and bottom door flanges providing a rigid torque-free door. A 1-1/2" wide stiffener will be furnished for 9" wide Marquis doors.



MARQUIS CLASSIC DOOR LINER

18 gauge full width door liner covers back of recessed handle. Built-in lock attaches to both door liner and recessed handle for maximum security and rigidity.



FEATURES

BODY CONSTRUCTION: Fully-framed all-welded Hollow-T construction, 18 gauge fully-framed solid sides, 16 gauge continuous top, 18 gauge solid back, 16 gauge galvaneal bottom

DOORS: 14 gauge plain doors with a full height 3" wide 18 gauge door stiffener are standard. Louvered, Security-Plus and diamond perforated door styles are optional

HANDLE: Deep-drawn seamless stainless steel recessed handle

LATCHING: Single-point maintenance-free quiet latching with 11 gauge MIG welded latch

HINGES: Heavy-duty 13 gauge 7-knuckle 3-1/2" hinges:

- 3-hinges per opening 48" high and higher
- 2-hinges per opening 20" high thru 36" high

SHELVES: 16 gauge galvaneal hat shelf for single tier openings 60" and 72" high, 16 gauge galvaneal intermediate shelves

HOOKS: 2-single hooks and 1-double hook is standard. 1-double hook only for triple tier and 1-double and 1-single hook for 9" wide openings 30" and higher

FOR MORE INFO GO TO
LISTINDUSTRIES.COM

FULLY-FRAMED ALL-WELDED LOCKERS

MILITARY GRADE TA-50

Manufactured with top quality steel and built to strict specifications, our TA-50 Military Grade Locker is the solution to all your storage challenges.

Secure, durable and guaranteed to last a lifetime.



Rough, Tough and Ready to Go!



FULLY-FRAMED ALL-WELDED LOCKERS

MILITARY GRADE TA-50



STANDARD



Rugged 3/16" Steel Handle is prepared for use with a padlock. Doors are pre-punched to accommodate a built-in combination or key lock if desired

STANDARD



Heavy-duty 13 gauge 7-knuckle 3-1/2" butt hinges. Handle: 3-point turn-handle latching with 3/8" diameter locking rods for maximum security



TA-50 GEAR LOCKER AVAILABLE SIZES

Widths: 36-1/2", 42-3/8", 48-1/4"
 Depths: 18", 22", 24"
 Heights: 74-3/4", 78", 84"

FEATURES

BODY CONSTRUCTION: Fully-framed all-welded construction, 13 gauge 1/2" fully-framed flattened expanded metal sides, 16 gauge top, 18 gauge solid back and 16 gauge galvalneal bottom. Optional solid sides are available.

DOORS: 14 gauge diamond perforated doors with 18 gauge full-height door stiffener for both doors is standard. Louvered, Security-Plus and plain door styles are available

HANDLE: 3-point turn-handle latching

SHELVES: 16 gauge galvalneal upper shelf located 12" down from top, 16 gauge galvalneal lower shelf located 18" up from bottom and 16 gauge galvalneal bottom shelf

DOOR HINGES: Heavy-duty 13 gauge 7-knuckle 3-1/2" hinges

ACCESSORIES: Stainless steel coat rod located under upper shelf.



FOR MORE INFO GO TO
LISTINDUSTRIES.COM

EMERGENCY RESPONSE ALL-WELDED LOCKERS

TURN OUT GEAR FIREFIGHTER LOCKERS

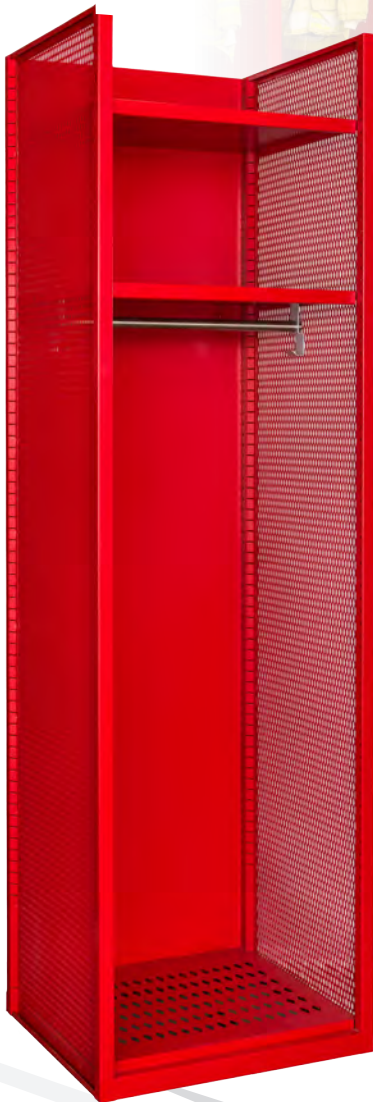

Base model shown with standard perforated base and stainless steel coat rod.



Shown with optional security box and optional foot locker.



Shown with optional ventilated door and metal base.

EMERGENCY RESPONSE ALL-WELDED LOCKERS

TURN OUT GEAR FIREFIGHTER LOCKERS



- ✓ Fully-framed, all welded, rugged construction.
- ✓ Maximum ventilation with expanded metal sides.
- ✓ Upper shelf provides storage for helmets and head gear.
- ✓ Without base models include ventilated bottom.
- ✓ Open-front provides quick access to gear and clothing.
- ✓ 721 Relay Red hammertone textured powder coat finish.



Optional Security Box uses Two heavy-duty 13 gauge 7-knuckle 3-1/2" hinges and a finger pull padlock hasp



Models with base are designed to be installed on the floor



Fixed hat shelf and stainless steel coat rod with 2 single prong hooks



Models without base have ventilated bottom plate and are designed to be installed on the wall with the wall mounting angle

Single-point thru-the-door projecting Antimicrobial finger pull for protection against bacteria with padlock hasp.



GENERAL SPECIFICATIONS

BODY CONSTRUCTION: Fully-framed all-welded Hollow-T construction, 13 gauge 1/2" fully-framed flattened expanded metal sides, 18 gauge solid back, 16 gauge galvanized bottom.

DOORS (OPTIONAL): 14 gauge galvanized steel. Security box door is solid. Full-height door is diamond perforated and includes 18 gauge door stiffener.

HANDLE/LATCHING: Optional security box has a single-point thru-the-door projecting **ANTIMICROBIAL FINGER PULL** for protection against bacteria. Optional foot locker is prepared for padlocks only.



HINGES: Optional doors have heavy-duty 13 gauge 7-knuckle 3 1/2" hinges.

SHELVES: Two upper 16 gauge galvanized steel shelves are standard.

HOOKS/COAT ROD: Four single prong hooks and stainless steel coat rod are standard.

FOR MORE INFO GO TO LISTINDUSTRIES.COM

EMERGENCY RESPONSE ALL-WELDED LOCKERS



*Perfect for SWAT, Police,
Fire & First Responders*

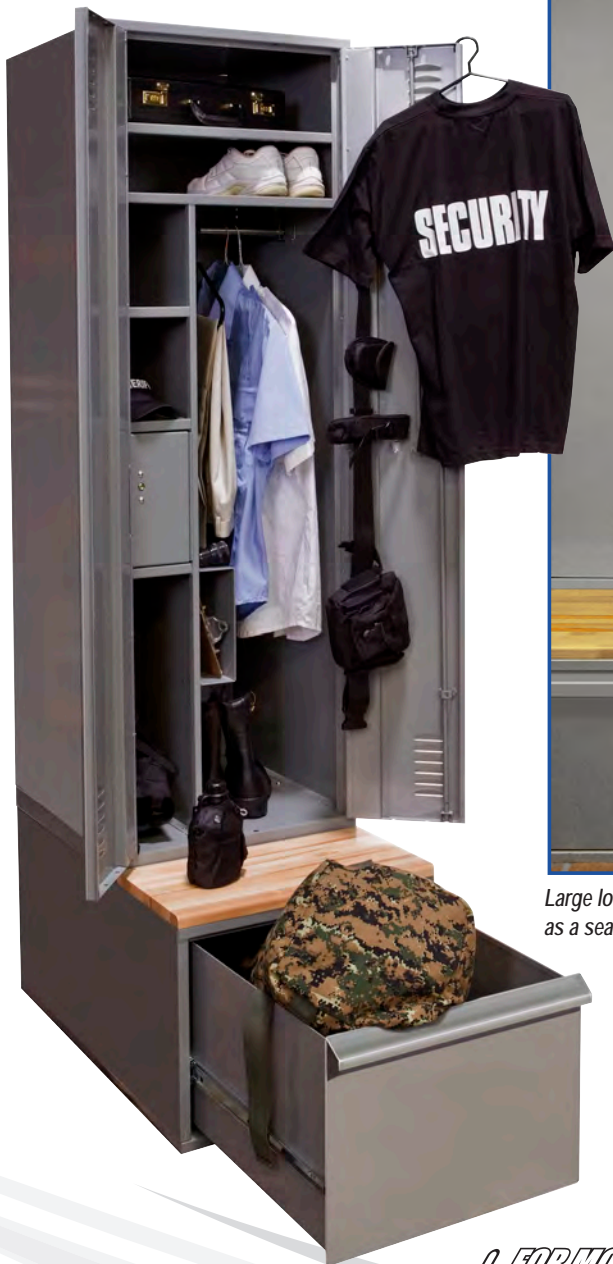

Large lockable storage compartment doubles as a seat finished in laminated maple wood.



*FOR MORE INFO GO TO
LISTINDUSTRIES.COM*



EMERGENCY RESPONSE ALL-WELDED LOCKERS

TASK FORCE XP

Provides the perfect solution for the storage needs of emergency response teams.



- ✓ **Utility belt hook**
- ✓ **Security box**
- ✓ **One side pocket shelf for a 1" thick clipboard**
- ✓ **Full height piano hinge**
- ✓ **Finish is standard powder-coat**
- ✓ **Full height door stiffeners**
- ✓ **Lower storage area with pull-out drawer**
- ✓ **Auto-Locking drawer is activated by upper doors**
- ✓ **Electrical Knockout in locker top - outlet and wiring by others**



Standard electrical knockout at locker top right rear corner

OPTIONS

- PEGBOARD DOOR STIFFENER
- BOOT TRAY
- BODY ARMOR DRYING RACK
- PERSONAL ITEMS ACCESSORY TRAY
- LOUVERED DRAWER FRONT
- PERFORATED RE-ENFORCED TOP
- AIRFLOW GAP
- SHELVES SPACED AWAY FROM BACK FOR ADDED AIRFLOW

Available with and without base storage compartment and seat

STANDARD UPPER UNIT SIZES

Widths: 24", 30", 36"
 Depths: 18", 24"
 Height: 72"

STANDARD BASE UNIT SIZES

Widths: 24", 30", 36"
 Depths: 30" 36"
 Height: 18"



FEATURES

BODY CONSTRUCTION: 16 gauge, Unibody all-welded, sides, galvanneal corrosion resistant sheet steel.

BACK: 18 gauge.

BODY STYLES: Single tier, custom design for specialized use.

FEATURES: Security box (9" x 12") with keyed lock.

DOOR: 14 gauge louvered double doors with full-height welded in stiffener.

HINGES: Continuous piano type.

HANDLE: 3/16" Steel handle with high security 3-point turn handle latching and 3/8" diameter steel locking rods.

HOOKS: Two single wall hooks in wardrobe area plus single hook for opening below security box.

COAT RODS: One at vertical wardrobe section.

SHELVES: Two full-width at top, one partial shelf above security box.

UNIBODY ALL-WELDED CORRIDOR LOCKERS

WHAT IS UNIBODY ALL-WELDED?

- Superior unibody all-welded corridor lockers include our double vertical frame design adding strength, integrity, durability and visual appeal.
- First we start with prime grade cold rolled sheet steel. 16 gauge for all body components except backs which are 18 gauge. Doors are heavy 14 gauge.
- Sides are formed to be an integral part of the front vertical locker frame which locks into the bottom for precise alignment and added strength.
- We MIG weld an additional channel shaped vertical frame member between doors providing a continuous door strike at both the hinge and latch side of the door.

- The top and bottom are flanged downward at the front to form a 1-1/2" high channel shaped top and bottom horizontal frame member continuous across the multiple column unit up to 60" wide.
- The base is a full 1-1/2" high keeping locker contents away from moisture on the floor and/or wood/concrete base.
- Front-to-back channel stiffeners are welded into the base under each side panel providing a strong anchor bearing surface for installation and increasing overall unit strength.
- Horizontal tier dividers for double and triple tier models project through to the face of the locker forming a horizontal cross member between doors for maximum strength.
- Guaranteed in writing by our lifetime warranty.

THE CLASSMATE™ CORRIDOR LOCKERS

Our unique double frame, unibody all-welded design provides a durable locker with a classic appearance that is backed by our life-time warranty.



Single Tier
3-Wide

Double Tier
3-Wide

Triple Tier
3-Wide



INTEGRAL SLOPE TOP is fabricated of heavy 16 gauge steel, runs continuous across a multiple column unit and is MIG welded at the factory replacing welded locker unit flat top. Sides are sloped at top providing rigid support beneath the slope top between each locker column.



PREMIER SERIES CLASSMATE which includes a 3" wide 18 gauge full height door stiffener spot welded to the inner door face and MIG welded to the hinge side as well as to the top and bottom door flanges providing a rigid torque-free door. A 1-1/2" wide stiffener will be furnished for 9" wide Premier doors. 18" and 24" all-welded lockers are only available in Premier Series.



FOR MORE INFO GO TO
LISTINDUSTRIES.COM

UNIBODY ALL-WELDED CORRIDOR LOCKERS

CLASSMATE™ Z-STYLE

The new Z-Style Unibody lockers creates a unique multi-height storage with extended hanging space on one side and built in shelf on the other, its like a two tier with the space of a single tier.



STANDARD **ANTIMICROBIAL PROTECTION**



Deep-drawn 304 stainless steel recessed handle with multi-point gravity lift-type latching includes our Antimicrobial Recessed Handle Finger Lift Cover for protection against bacteria

STANDARD



12 gauge latch hooks MIG welded to frame.

STANDARD



16 gauge continuous piano hinge



FEATURES

BODY CONSTRUCTION: All-welded unibody construction, 16 gauge solid sides integral with frame, 16 gauge continuous top, 18 gauge solid back, 16 gauge bottom

DOORS: 14 gauge louvered doors are standard. Plain, Security-Plus, Safety-View and diamond perforated door styles are optional

HANDLE: Deep-drawn 304 seamless stainless steel recessed handle

DOOR STRIKE: Continuous vertical door strike at both hinge and latch side

HINGES: 16 gauge continuous piano type

LATCHING: 12 gauge latch hooks MIG welded to frame. Gravity lift-type multi-point spring loaded latching:

- 3-point latching for openings 48" high and higher
- 2-point latching for openings 20" high thru 36" high

Lock Bars are fabricated from G90 galvanized steel and are installed into the door after paint

HOOKS: 2-single hooks and 1-double hook is standard.

- 1- double hook only for triple tier 1-double
- 1-double & 1- single hook for 9" wide openings 30" and higher

SHELVES: 16 gauge hat shelf for single tier openings 60" and 72" high, 16 gauge intermediate shelves.



UNIBODY ALL-WELDED CORRIDOR LOCKERS

MARQUIS® BOOKSAFE® III CORRIDOR LOCKERS

Our third generation Marquis Booksafe locker includes reinforced double frame, unibody construction and a modern seamless deep-drawn stainless steel recessed handle. The industry's first and best single-point, all-welded corridor

locker just got better, stronger and more durable, and backed by our written lifetime warranty. Doors are provided without louvers for a clean flush front.



Single Tier
3-Wide

Triple Tier
3-Wide

WHAT IS UNIBODY ALL-WELDED?

- Superior unibody all-welded corridor lockers include our double vertical frame design adding strength, integrity, durability and visual appeal.
- First we start with prime grade cold rolled sheet steel. 16 gauge for all body components except backs which are 18 gauge. Doors are heavy 14 gauge.
- Sides are formed to be an integral part of the front vertical locker frame which locks into the bottom for precise alignment and added strength.
- We MIG weld an additional channel shaped vertical frame member between doors providing a continuous door strike at both the hinge and latch side of the door.

- The top and bottom are flanged downward at the front to form a 1-1/2" high channel shaped top and bottom horizontal frame member continuous across the multiple column unit up to 60" wide.
- The base is a full 1-1/2" high keeping locker contents away from moisture on the floor and/or wood/concrete base.
- Front-to-back channel stiffeners are welded into the base under each side panel providing a strong anchor bearing surface for installation and increasing overall unit strength.
- Horizontal tier dividers for double and triple tier models project through to the face of the locker forming a horizontal cross member between doors for maximum strength.
- Guaranteed in writing by our lifetime warranty.

UNIBODY ALL-WELDED CORRIDOR LOCKERS

MARQUIS® BOOKSAFE® III
CORRIDOR LOCKERS



Double Tier
3-Wide



INTEGRAL SLOPE TOP is fabricated of heavy 16 gauge steel, runs continuous across a multiple column unit and is MIG welded at the factory replacing welded locker unit flat top. Sides are sloped at top providing rigid support beneath the slope top between each locker column.

STANDARD



Deep-drawn 304 stainless steel recessed handle with single-point latching

STANDARD



11 gauge single-point latch MIG welded to Hollow-T frame

STANDARD



16 gauge continuous piano hinge

STANDARD



Include a 3" wide 18 gauge full height door stiffener spot welded to the inner door face and MIG welded to the hinge side as well as to the top and bottom door flanges providing a rigid torque-free door. A 1-1/2" wide stiffener will be furnished for 9" wide Marquis doors.



MARQUIS CLASSIC DOOR LINER

18 gauge full width door liner covers back of recessed handle. Built-in lock attaches to both door liner and recessed handle for maximum security and rigidity.



FEATURES

BODY CONSTRUCTION: All-welded unibody construction, 16 gauge solid sides integral with frame, 16 gauge continuous top, 18 gauge solid back, 16 gauge bottom

DOORS: 14 gauge plain doors with a 3" wide 18 gauge full height door stiffener are standard. Louvered, Security-Plus and diamond perforated door styles are optional

HANDLE: Deep-drawn 304 seamless stainless steel recessed handle with single-point latching

DOOR STRIKE: Continuous vertical door strike at both hinge and latch side

LATCHING: Single-point maintenance-free quiet latching with 11 gauge MIG welded latch

HINGES: 16 gauge continuous piano type is standard. Heavy-duty 13 gauge 3-1/2" 7 knuckle hinges are available as an upgrade

HOOKS: 2-single hooks and 1-double hook is standard.

- 1- double hook only for triple tier 1-double
- 1-double & 1- single hook for 9" wide openings 30" and higher

SHELVES: 16 gauge hat shelf for single tier openings 60" and 72" high, 16 gauge intermediate shelves.

UNIBODY ALL-WELDED LOCKERS

CUBBIE[™]

CHILDREN SAFE!

The Superior[®] Cubbie Locker line is designed for early childhood and elementary school classrooms. The Unibody, all-welded locker construction and the added safety features exceed the

requirements of this specialized market. Our line offers four models designed to meet any child's personal storage needs. Superior[®] Cubbies are backed by our written lifetime warranty.

Rounded Corners and Hemmed Edges!



CORROSION RESISTANT BOTTOM

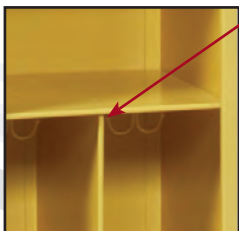

Hemmed and beaded edges eliminate sharp edges

Number plate in bottom of cubbie so children can easily identify their cubbie space.

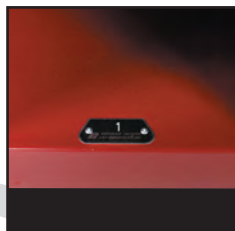

CUBBIE™

by List Industries Inc.

**4 MODELS &
24 COLORS**



Primary Cubbie

Primary II Cubbie

Primary Jr. Cubbie

Backpack Cubbie



MODEL SIZES	WIDTH	DEPTH	HEIGHT
Primary Cubbie	12", 15"	12", 16"	48"
Primary II Cubbie	12", 15"	12", 16"	48"
Primary Jr. Cubbie	12", 15"	12", 16"	24"
Backpack Cubbie	15", 18"	12", 16"	48"

FEATURES

BODY CONSTRUCTION: Unibody all-welded 16 gauge steel construction, backs are 18 gauge, bottom is galvanized sheet steel for maximum corrosion resistance, hemmed and beaded edges are safe to the touch.

BODY STYLES: Open design, 4 body styles.

SHELVES: 16 gauge welded to body for added rigidity with a beaded leading edge for added safety.

NOTES: Easily secures to wall and floor for added safety, low installation costs, reduced installation time, low maintenance, low life-cycle cost, lifetime warranty, insect and termite proof. All welded cubbies will ship in multiple column units up to 60" wide to meet individual jobsite conditions.



FOR MORE INFO GO TO
LISTINDUSTRIES.COM

SUPERIOR
AMERICA'S MOST COMPLETE LOCKER LINE

CLASSIC KD WARDROBE LOCKERS



SINGLE TIER
Provides ample height for hanging of full length garments.

DOUBLE TIER
Where full length hanging of garments is not required double tier lockers offer an economical alternative.

TRIPLE TIER
Triple tier lockers are ideal for use where storage of long garments is not required.

Z-TIER
A unique multi-height storage with extended hanging space on one side and built in shelf on the other, its like a two tier with the space of a single tier.
For sizes and info call 800-776-1342 or e-mail info@ListIndustries.com

STANDARD



Deep-drawn 304 stainless steel recessed handle with multi-point gravity lift-type latching includes our Antimicrobial Recessed Handle Finger Lift Cover for protection against bacteria



STANDARD



16 gauge continuous piano hinge

STANDARD



12 gauge latch hook is welded to frame

STANDARD KD WARDROBE LOCKER SIZES

TIER	WIDTH	DEPTH	OPENING HEIGHT	FRAME HEIGHT
Single Tier	9" 12" 15" 18" 24"	12" 15" 18" 21" 24"	36" 48" 60" 72"	36" 48" 60" 72"
Double Tier	9" 12" 15" 18"	12" 15" 18" 21" 24"	30" 36"	60" 72"
Triple Tier	9" 12" 15"	12" 15" 18" 21" 24"	20" 24"	60" 72"

MAX OPTION UPGRADE all body components to 16 gauge with 18 gauge back. Recommended when placing heavy items in lockers such as backpacks.



FEATURES

BODY CONSTRUCTION: Knock down (KD) 24 gauge solid body components

DOORS: 16 gauge louvered doors, 18 gauge for 9" wide are standard. Security-Plus, Safety-View and diamond perforated door styles are available. See Standard Quiet lockers on page 38 for plain door option

LATCHING: 12 gauge latch hooks MIG welded. Gravity lift-type multi-point spring loaded latching:

- 3-point latching for openings 48" high and higher
- 2-point latching for openings 20" high thru 36" high

Lock Bars are made from G90 galvanized steel and installed after powdercoat.

FRAME: 16 gauge frame with 16 gauge horizontal cross member between doors on double and triple tier wardrobe lockers

DOOR STRIKE: Continuous vertical door strike at both hinge and latch side

HOOKS: 2-single hooks and 1-double hook is standard.

- 1- double hook only for triple tier 1-double
- 1-double & 1- single hook for 9" wide openings 30" and higher

SHELVES: Hat shelf for single tier openings 60" and 72" high

NOTES: All production KD lockers are supplied without legs unless otherwise specified

CLASSIC KD BOX LOCKERS

**Box Lockers are Ideal
Where Space is a Premium**



Four Tier

Five Tier

Six Tier

STANDARD



Single-point thru-the-door projecting Antimicrobial finger pull for protection against bacteria with padlock hasp is standard for side hinged doors

STANDARD



16 gauge continuous piano hinge



OPTION
STRIKE PLATE

Padlock Strike Plates for box doors protect finish from being marred by padlock



MAX UPGRADE all body components to 16 gauge with 18 gauge back. Recommended when placing heavy items in lockers such as backpacks.

STANDARD KD BOX LOCKER SIZES

TIER	WIDTH	DEPTH	OPENING HEIGHT	FRAME HEIGHT
Four Tier	12" 15"	12" 15" 18"	15" 18"	60" 72"
Five Tier	12" 15"	12" 15" 18"	12" 14.4"	60" 72"
Six Tier	12" 15"	12" 15" 18"	12"	72"



FEATURES

BODY CONSTRUCTION: Knock down (KD) with 24 gauge solid body components

DOORS: 18 gauge louvered doors are standard. Plain, Security-Plus and diamond perforated door styles are available

FRAME: 16 gauge frame

HANDLE: Projecting finger pull

DOOR STRIKE: Continuous vertical door strike at both hinge & latch side

LATCHING: Single-point thru-the-door antimicrobial finger pull padlock hasp

HINGES: 16 gauge continuous piano type

NOTES: All production KD lockers are supplied without legs unless otherwise specified.

FOR MORE INFO GO TO
LISTINDUSTRIES.COM

SPECIALTY KD WARDROBE & BOX LOCKERS

When you need an economical multi-purpose, practical and space-saving locker solution.



FOUR-WIDE WALL MOUNT

Wall mount Lockers provide ample additional storage space for 4 persons. Wall mount lockers can be used as supplemental storage in combination with other lockers or in specific applications where floor space is limited and storage requirements must be met. 48" wide under-mount coat rod is optional.

STANDARD



Single-point thru-the-door projecting Antimicrobial finger pull for protection against bacteria with padlock hasp is standard for side hinged doors

STANDARD



16 gauge continuous piano hinge

SIXTEEN-PERSON

An economical solution for personal security along and hanging space for full length garments. Ideal for student and teacher lounges, offices, commercial and retail establishments. Sixteen-Person lockers come with standard 6" high legs; 48" coat rod included



OPTION

STRIKE PLATE

Padlock Strike Plates for box doors protect finish from being marred by padlock

STANDARD KD SPECIALTY LOCKER SIZES

MODEL	WIDTH	DEPTH	OPENING HEIGHT	FRAME HEIGHT
Two-Person	15", 18"	12", 15", 18", 21"	N/A	60", 72"
Duplex	15"	12", 15", 18", 21"	60", 72"	60", 72"
Sixteen-Person	72"	18"	12"	78" (with 6" legs)
4-Wide Wall Mount	48"	18"	12"	14-3/4"

SPECIALTY KD WARDROBE & BOX LOCKERS

Duplex & Two Person Lockers



DUPLEX

The most economical full length locker available, it conserves valuable floor space, yet provides ample height for hanging full length garments. Duplex lockers provide two completely private lockers in each frame. One hat shelf and two single hooks are standard in each wardrobe opening. Coat rods are optional for 18" and deeper models.



TWO-PERSON

Two-Person lockers provide ample storage space for two users in a 15" or 18" wide space. Upper box doors are controlled by command latches located in the corresponding lower compartment. Two single hooks per wardrobe opening are standard. Coat rods are optional for 18" and deeper.



STANDARD

Upper box door of Two-Person locker is opened from within user's wardrobe compartment

STANDARD



Deep-drawn 304 stainless steel recessed handle with multi-point gravity lift-type latching includes our Antimicrobial Recessed Handle Finger Lift Cover for protection against bacteria

STANDARD



12 gauge latch hook is welded to frame

STANDARD FOR BOX DOOR



16 gauge continuous piano hinge

FEATURES

BODY CONSTRUCTION: Knock down (KD) with 24 gauge solid body components.

DOORS: 16 gauge louvered doors, 18 gauge for 9" wide are standard. Security-Plus, Safety-View and diamond perforated door styles are available.

LATCHING: 12 gauge latch hooks MIG welded to frame. Gravity lift-type multi-point spring loaded latching:

- 3-point latching for openings 48" high and higher
- 2-point latching for openings 20" high thru 36" high

Lock Bars are fabricated from G90 galvanized steel and are installed into the door after paint.

FRAME: 16 gauge frame with 16 gauge horizontal cross member between doors on double and triple tier wardrobe lockers.

DOOR STRIKE: Continuous vertical door strike at both hinge and latch side.

HOOKS: 2-single hooks and 1-double hook is standard.

- 1- double hook only for triple tier 1-double
- 1-double & 1- single hook for 9" wide openings 30" and higher .

SHELVES: Hat shelf for single tier openings 60" and 72" high



QUIET & WHISPER QUIET KD WARDROBE LOCKERS

Our Silent Approach To Locker Design



Double Tier
1-Wide

STANDARD QUIET

Lockers are constructed just like our Classic K.D. lockers, except the door is furnished without louvers to limit air rush through the door, providing quiet operation. Perforations on upper and lower door flanges allow concealed ventilation.



DOOR FEATURES

Perforated top and bottom door flanges for all Standard Quiet and Whisper Quiet lockers allow for concealed ventilation



WHISPER QUIET

The die-formed sound deadening panel filled with acoustical material provide the quietest and most aesthetically appealing gravity latch locker.

STANDARD



Deep-drawn 304 stainless steel recessed handle with multi-point gravity lift-type latching includes our Antimicrobial Recessed Handle Finger Lift Cover for protection against bacteria

STANDARD



12 gauge latch hook is welded to frame

STANDARD



16 gauge continuous piano hinge



UPGRADES all body components to 16 gauge with 18 gauge back. Recommended when placing heavy items in lockers such as backpacks.



FEATURES

BODY CONSTRUCTION: Knock down (KD) 24 gauge solid body components

DOORS: 16 gauge plain doors (18 gauge for 9" wide), sound deadening panel for Whisper Quiet lockers only

FRAME: 16 gauge frame with 16 gauge horizontal cross member between doors on double and triple tier wardrobe lockers

HANDLE: Deep-drawn stainless steel recessed handle

DOOR STRIKE: Continuous vertical door strike at both hinge and latch side

HINGES: 16 gauge continuous piano type

LATCHING: 12 gauge latch hooks MIG welded to frame. Gravity lift-type multi-point spring loaded latching:

- 3-point latching for openings 48" high and higher
- 2-point latching for openings 20" high thru 36" high
- Isolated latching mechanism for Whisper Quiet only

Lock Bars are fabricated from G90 galvanized steel and are installed into the door after paint.

HOOKS: 2-single hooks and 1-double hook is standard.

- 1- double hook only for triple tier 1-double
- 1-double & 1- single hook for 9" wide openings 30" and higher

SHELVES: Hat shelf for single tier openings 60" and 72" high

SIZES: See page 34

NOTES: All production KD lockers are supplied without legs unless otherwise specified. Standard Quiet and Whisper Quiet lockers are available with plain doors only. Additional perforations/louvers in the door will increase decibel levels thus reducing the efficiency of our quiet design

HEAVY-DUTY CORRIDOR (HDC) KD WARDROBE LOCKERS

Built to Last!



Single Tier
1-Wide

Double Tier
1-Wide

Triple Tier
1-Wide

HEAVY-DUTY CORRIDOR LOCKERS, commonly known as HDC lockers, are designed to include all the great features of our Classic KD wardrobe lockers; however, the door gauge is increased to 14 gauge which is 25% heavier than standard 16 gauge doors. To further increase door integrity, we offer our HDC Premier model which includes an 18 gauge full height door stiffener.



PREMIER HDC LOCKERS
Include a 3" wide 18 gauge full height door stiffener. A 1-1/2" wide stiffener will be furnished for 9" wide Premier doors.



STANDARD  **ANTIMICROBIAL PROTECTION**



Deep-drawn 304 stainless steel recessed handle with multi-point gravity lift-type latching includes our Antimicrobial Recessed Handle Finger Lift Cover for protection against bacteria

STANDARD



12 gauge latch hook is welded to frame

STANDARD



16 gauge continuous piano hinge



FEATURES

BODY CONSTRUCTION: Knock down (KD) with 24 gauge solid body components

DOORS: 14 gauge louvered doors are standard. Plain, Security-Plus, Safety-View and diamond perforated door styles are available

FRAME: 16 gauge frame with 16 gauge horizontal cross member between doors on double and triple tier wardrobe lockers

HANDLE: Deep-drawn seamless stainless steel recessed handle

DOOR STRIKE: Continuous vertical door strike at both hinge and latch side

HINGES: 16 gauge continuous piano type

NOTES: All production KD lockers are supplied without legs unless otherwise specified

LATCHING: 12 gauge latch hooks MIG welded to frame. Gravity lift-type multi-point spring loaded latching:

- 3-point latching for openings 48" high and higher
- 2-point latching for openings 20" high thru 36" high

Lock Bars are fabricated from G90 galvanized steel and are installed into the door after paint.

HOOKS: 2-single hooks and 1-double hook is standard.
1-double hook only for triple tier and 1-double
1-single hook for 9" wide openings 30" and higher

SHELVES: Hat shelf for single tier openings 60" and 72" high

SIZES: See page 34

FOR MORE INFO GO TO LISTINDUSTRIES.COM

STUDENT KD LOCKERS

MARQUIS® STUDENT KD LOCKERS

Since 1983, Superior® Marquis Student KD lockers are the most specified single-point lockers in the marketplace. Designed with superior features usually reserved

for heavy-duty athletic lockers, our sixth generation Marquis Student locker is an engineering achievement.



Single Tier
1-Wide

Double Tier
1-Wide

Triple Tier
1-Wide

STANDARD



Deep-drawn 304 stainless steel recessed handle with single-point latching

STANDARD



16 gauge continuous piano hinge

STANDARD



11 gauge single-point latch MIG welded to Hollow-T frame

STANDARD



Includes a 3" wide 18 gauge full height door stiffener, spot welded to the inner door face and MIG welded to the hinge side as well as to the top and bottom door flanges providing a rigid torque-free door. A 1-1/2" wide stiffener will be furnished for 9" wide Marquis doors.

MAX OPTION UPGRADES all body components to 16 gauge with 18 gauge back. Recommended when placing heavy items in lockers such as backpacks.



UPGRADE

MARQUIS CLASSIC DOOR LINER

18 gauge full width door liner covers back of recessed handle. Built-in lock attaches to both door liner and recessed handle for maximum security and rigidity.



FEATURES

BODY CONSTRUCTION: Knock down (KD) with 24 gauge solid body components

DOORS: 14 gauge plain doors with 18 gauge full-height door stiffener are standard. Louvered, Security-Plus and diamond perforated door styles are available

FRAME: 16 gauge frame with 16 gauge horizontal cross member between doors on double and triple tier wardrobe lockers

HANDLE: Deep-drawn seamless stainless steel recessed handle

DOOR STRIKE: Continuous vertical door strike at both hinge and latch side

LATCHING: Single-point maintenance-free quiet, 11 gauge latch hooks MIG welded to frame

HINGES: 16 gauge continuous piano type is standard. Heavy-duty 13 gauge 3-1/2" 7-knuckle hinges are available as an upgrade

HOOKS: 2-single hooks and 1-double hook is standard.

- 1- double hook only for triple tier 1-double
- 1-double & 1- single hook for 9" wide openings 30" and higher

SHELVES: Hat shelf for single tier openings 60" and 72" high

NOTES: All production KD lockers are supplied without legs unless otherwise specified.

AFFORDABILITY AND FUNCTIONALITY IN ONE LOCKER

HEAVY-DUTY VENTILATED (HDV) KD LOCKERS

HEAVY-DUTY VENTILATED (HDV) knock-down lockers are the perfect solution when budget restrictions prevent the use of fully-framed all-welded lockers.



PREMIER SERIES HDV LOCKERS include our 3" wide 18 gauge full height door stiffener welded to the inner door face providing a rigid torque-free door. A 1-1/2" wide stiffener will be furnished for 9" wide Premier Series Wardrobe and 12" wide Premier Series Box Locker doors.



MARQUIS SERIES HDV LOCKERS which include our deep-drawn seamless stainless steel recessed handle with single-point latching, and a 3" wide 18 gauge full height door stiffener spot welded to the inner door face and MIG welded to the hinge side as well as to the top and bottom door flanges providing a rigid torque-free door. A 1-1/2" wide stiffener will be furnished for 9" wide Marquis Series doors.

STANDARD + **ANTIMICROBIAL PROTECTION**



Deep-drawn 304 stainless steel recessed handle with multi-point gravity lift-type latching includes our Antimicrobial Recessed Handle Finger Lift Cover for protection against bacteria

STANDARD



12 gauge latch hook is welded to frame

STANDARD



16 gauge continuous piano hinge

STANDARD + **ANTIMICROBIAL PROTECTION**



Single-point thru-the-door projecting Antimicrobial finger pull for protection against bacteria with padlock hasp is standard for side hinged doors



FEATURES

BODY CONSTRUCTION: (Wardrobe & Box lockers): Knock down (KD) with 16 gauge solid top, bottom and intermediate shelves, 16 gauge diamond perforated sides, 18 gauge solid back

DOORS: 14 gauge diamond perforated doors are standard. Louvered, Security-Plus and plain door styles are available

FRAME: 16 gauge frame with 16 gauge horizontal cross member between doors on double and triple tier wardrobe lockers

HANDLE: Wardrobe Lockers (doors 20" and higher) - Deep-drawn seamless stainless steel recessed handle, Box lockers - Single-point thru-the-door antimicrobial finger pull padlock hasp

HINGES: 16 gauge continuous piano type

DOOR STRIKE: Continuous vertical door strike at both hinge and latch side

LATCHING: Gravity lift-type multi-point spring loaded latching:

- 3-point latching for openings 48" high and higher,
- 2 point latching for openings 20" high thru 36" high

Lock Bars are fabricated from G90 galvanized steel and are installed into the door after paint.

HOOKS: 2-single hooks and 1-double hook is standard.

- 1- double hook only for triple tier 1-double
- 1-double & 1- single hook for 9" wide openings 30" and higher
- Box lockers no hooks

SHELVES: 16 gauge hat shelf for single tier openings 60" and 72" high

NOTES: All production KD lockers are supplied without legs unless otherwise specified

SAFETY-VIEW™ KD LOCKERS

**SAFETY
VIEW™**

Ideal For Monitoring Locker Contents



Double Tier lockers
(Also available in single and triple tier)



STANDARD

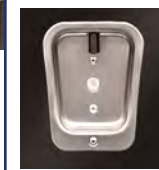

Deep-drawn 304 stainless steel recessed handle with multi-point gravity lift-type latching

STANDARD



12 gauge latch hook is welded to frame

STANDARD



16 gauge continuous piano hinge



FEATURES

BODY CONSTRUCTION: Knock-down, 24 gauge,

SPECIAL FEATURES: Wardrobe: Two, high strength injection molded polycarbonate panels per door for content viewing Box: High strength injection molded polycarbonate doors for content viewing

DOOR: 16 gauge (For wardrobe doors only)

HINGES: Continuous piano type

HANDLE: (wardrobe): Stainless steel recessed handle with multi-point gravity lift-type latching. Recessed handle protects finish from being marred by padlock. Single-point projecting friction catch door pull prepared for both padlock or built-in lock is standard for box doors

HOOKS: One double prong ceiling hook and two single hooks per single and double tier opening. One double ceiling hook for triple tier.

COAT RODS: Available for single tier at a nominal cost.

SHELVES: Hat shelf is included in 60" and 72" high single tier lockers. notes: Meets UL flammability standards, Polycarbonate is approved by the Consumer Product Safety Commission (CPSC16CFR 1201). All production lockers are standard with no legs unless otherwise specified. Safety-View doors are available as a retrofit to most lockers.

NOTES: Meets UL flammability standards, Polycarbonate is approved by the Consumer Product Safety Commission (CPSC16CFR 1201). All production lockers are standard with no legs unless otherwise specified. Safety-View doors are available as a retrofit to most lockers.

SAFETY-VIEW™ PLUS KD LOCKERS

SAFETY VIEW™ PLUS

See-thru doors



Sixteen-Person lockers
(6" high legs are standard)
Shown with optional closed metal base



4-wide wall mount lockers



Four and Six Tier Lockers
(also available in five tier)

STANDARD **ANTIMICROBIAL PROTECTION**



Single-point thru-the-door projecting Antimicrobial finger pull for protection against bacteria with padlock hasp is standard for side hinged doors

STANDARD



16 gauge continuous piano hinge

STANDARD SAFETY-VIEW & SAFETY VIEW PLUS LOCKER SIZES					
	MODEL	OPENING WIDTH	OPENING DEPTH	OPENING HEIGHT	FRAME HEIGHT
Safety-View Lockers	Single Tier	12"	12", 15", 18"	60", 72"	72"
	Double Tier	12"	12", 15", 18"	30", 36"	72"
	Triple Tier	12"	12", 15", 18"	20", 24"	72"
Safety-View Plus Lockers	Four Tier	12"	12", 15", 18"	18"	72"
	Five Tier	12"	12", 15", 18"	12"	60"
	Six Tier	12"	12", 15", 18"	12"	72"
	Sixteen-Person	12"	18"	12"	78" with 6" legs
	4-Wide Wall Mount	12"	18"	12"	14-3/4"

UL GREENGUARD GOLD CERTIFIED
FOR MORE INFO GO TO LISTINDUSTRIES.COM

SUPERIOR
AMERICA'S MOST COMPLETE LOCKER LINE

304 STAINLESS STEEL LOCKERS

Attractive Durable Rust Resistant 304 Stainless Steel

The rich appearance and durable surface of Superior 304 Stainless Steel Lockers make them the perfect locker solution for areas prone to rust and sanitation concerns and are ideal for food industry, pool area and outdoor.



STANDARD FOR WARDROBE DOORS



Deep-drawn 304 stainless steel recessed handle with multi-point gravity lift-type latching

STANDARD



12 gauge latch hook is welded to frame

STANDARD FOR BOX DOOR



Single-point thru-the-door finger pull padlock hasp is standard for HDV box doors 18" high and under



Shown with optional 6" legs

GENERAL SPECIFICATIONS

BODY CONSTRUCTION: Knock down (KD) with 24 gauge 304 stainless steel body components

DOORS: 16 gauge 304 stainless steel louvered doors are standard.

FRAME: 16 gauge 304 stainless steel frame with 16 gauge horizontal cross member between doors on double tier wardrobe lockers

HANDLE: Wardrobe doors have a deep-drawn seamless 304 stainless steel recessed handle. Box doors the projecting finger-pull handle is standard

DOOR STRIKE: Continuous vertical door strike at both hinge and latch side

LATCHING (WARDROBE): 12 gauge latch hooks MIG welded to frame. Gravity lift-type multi-point spring loaded latching:

- 3-point latching for openings 48" high and higher
- 2-point latching for openings 20" high thru 36" high

LATCHING (BOX): Single-point thru-the-door antimicrobial finger pull padlock hasp

HINGES: 2" long 16 gauge 5-knuckle stainless steel hinges. 3 hinges for doors 48" and higher and 2 for doors under 48" high.

HOOKS: 2-single hooks and 1-double hook is standard. 1- double hook only for triple tier and 1-double and 1 - single hook for 9" wide openings 30" and higher. No hooks in openings less than 20" high.

SHELVES: Hat shelf for single tier openings 60" and 72" high

NOTES: All production KD lockers are supplied without legs unless otherwise specified



FOR MORE INFO GO TO
LISTINDUSTRIES.COM

Superior® Locker Accessories



KD



KD



KD



KD/Welded



KD/Welded

SPECIFICATIONS

1 - 6" Closed Front Base (KD lockers only): Shall be fabricated of 16 gauge cold rolled sheet steel flanged on all four sides for rigidity. Front bases include projecting tabs on side flanges designed to align with holes in front legs allowing front bases to be snapped into place requiring no additional fasteners. Side bases are to be included at all exposed ends and are bolted to front and rear legs. Finish to match lockers.

2 - 4" Continuous Z-Base (KD lockers only): Shall be fabricated from 16 gauge cold rolled sheet steel fabricated in 72" lengths, flanged at the top to form a 1-3/8" toe space and at the bottom allowing concealed fastening to the finished floor. Continuous Front Bases include holes for use with splice plates where bases are joined end-to-end. End Bases are to be included at all exposed ends. Where additional support is desired, End Bases may be substituted for splices at Continuous Front Base joints. Finish to match lockers.

3 - 20 gauge Individual Slope Top (KD lockers only): Not less than 20 gauge cold rolled sheet steel, 18 degree pitch, fabricated to be installed individually over each locker. Slope top is formed to include a full back. Individual Slope Tops are to be installed in addition to the locker flat top. End closures are to be provided at exposed ends. Finish to match lockers.

4 - 18 gauge Continuous Slope Top: Not less than 18 gauge cold rolled sheet steel, 18 degree pitch, in 72" lengths. A splice cover with concealed spring clip is to be used to cover joints where Continuous Slope Tops are joined end-to-end. To be installed in addition to the locker flat top with end closures for support. Finish to match lockers.

4 - 16 Gauge Continuous Slope Top: Not less than 16 gauge cold rolled sheet steel, 18 degree pitch, in 72" lengths. A splice cover with concealed spring clip is to be used to cover joints where Continuous Slope Tops are joined end-to-end. To be installed in addition to the locker flat top with end closures for support. Finish to match lockers.

5 - Recessed Trim: Fabricated of 16 gauge cold rolled sheet steel. 3" wide side trim shall be notched at the top and include a retainer to allow the 3" wide top trim to fit snugly into the side trim. Recess trim is designed to be used when the lockers are installed with the locker fronts flush with the top and side walls. The top and side trim will project 3/8" beyond the side and top walls and include return bends back to the walls. Finish to match lockers.

6 - Minimum Punched End Panel (KD lockers only): Shall be from 18 gauge cold rolled steel and formed to fit tightly over the universal side panel at exposed row ends. Holes are provided at perimeter for fastening to locker. Minimum Punched End Panels are designed to cover all fasteners other than those at the perimeter of the panel. Finish to match lockers. Provide at all exposed ends.

7 - Boxed End Panel: Shall be "Boxed" type formed from 16 gauge cold rolled steel with 1" O.D. double bends on sides and a single bend at top and bottom with no exposed holes or bolts. If lockers have slope tops, end panels must be formed with slope at top to cover the ends of the slope tops. Finish to match lockers. Provide at all exposed ends.

8 - Fillers: Provide where indicated, of not less than 16 gauge cold rolled sheet steel, factory fabricated and finished to match lockers.



KD



KD/Welded



KD/Welded

LOCKER BENCHES & PEDESTALS

Pedestals



4805 HEAVY DUTY STEEL PEDESTAL
Fabricated from 14 gauge tube steel with 11 gauge formed flanges.
Color: TAN



8032 ADJUSTABLE STEEL PEDESTAL
With cast aluminum base and concealed anchoring to floor.
Color: TAN



4810 EXTRA HEAVY-DUTY CAST IRON PEDESTAL
With 6" diameter top and bottom flanges with three anchoring holes.
Color: TAN



4820 ALUMINUM MOVEABLE PEDESTAL
Includes holes for optional permanent anchoring to floor. **Color: TAN**



4825 STAINLESS STEEL PEDESTAL
Fabricated from 16 gauge stainless steel. Designed for movable and fixed use.
Color: Unpainted

Benches

WHITE NORTHERN HARD WOOD

Locker Benches are 9-1/2" wide x 1-1/4" thick, made from laminated white northern hard wood, and finished with one coat, deep-penetrating hot sealer, and two coats of heavy body, high-impact, hot, hydraulically applied lacquer. Bench tops are standard in one foot increments from 3' thru 12'. Non-standard lengths are available on special order (pedestal requirement will be for next standard size up).

BENCH TOP LENGTH	3' - 8'	9' - 12'
PEDESTALS REQUIRED	2	3

Note: Bench top lengths over 12' will be supplied in sections

PHENOLIC

Locker Benches are 9 1/2" x 3/4" Thick, made from Formica® phenolic in choice of 18 standard colors. See page 89 for color choices. Available in 1 foot increments from 3' to 12'.

BENCH TOP LENGTH	3' - 5'	6' - 8'	9' - 12'
PEDESTALS REQUIRED	2	3	4

Pedestal space not to exceed 40" O.C.



SHOWN WITH 4820 PEDESTALS



SHOWN WITH 4810 PEDESTALS



LOCKS

Padlocks, Built-in Locks & Specialty Locks

List Industries recommends **MASTER® locks** for use on all Superior Lockers.



Master Lock Co.
Built-In Combination Locks

Available in spring-bolt and dead-bolt styles, are key controlled and include multiple combination settings.

 ADA Compliant
Version Available



Master Lock Co.
Combination Padlocks

Available standard and master-keyed, Master Lock padlocks can be used on all locker types.

 ADA Compliant
Padlocks Available



Master Lock Co.
Built-In Key Locks

Available in spring-bolt and dead-bolt styles - Available in standard or master-keyed.

 ADA Compliant
Version Available



Hallowell
DIGITECH H1™ Locks

Digitech H1™ electronic access locks can be programmed for shared or permanent use

 ADA Compliant



SAFE-O-MAT® Built-In
Coin, Token & Card Locks

Available in coin return and coin collect as well as token collect and card access styles.



Hallowell
DIGITECH™ II RFID Locks

Digitech RFID electronic access locks can be programmed to work with most current RFID systems

 ADA Compliant



Hallowell
DIGITECH™ GL Locks

Digitech™ GL electronic locks are compatible with all Superior® gravity lift-type latching lockers. Lock fits nicely in our recessed handle

 ADA Compliant

NOTE: An ADA compliant lock must be used on any locker that is required to meet ADA guidelines.

DOOR VENTILATION OPTIONS

Know your List lockers

Please refer to individual product pages for applicable options.



*Plain Doors
(Quiet)*



*Louvered Doors
(Classic)*



*Louvered Doors
(With Door Stiffener)*



*Diamond Perforated
Doors
(High Ventilation)*



*Diamond Perforated
Doors
(With Door Stiffener)*



*Security-Plus Doors
(Security Ventilation)*



*Safety-View Doors
(See-thru Polycarbonate
Insert)*



*Safety-View Plus Box Doors
(See-thru Polycarbonate Door)
12" wide x 12" high and
12" wide x 18" high
KD box doors only*



*Hybrid Red Oak
Plain Door*



*Hybrid Red Oak
Panel Door*

MODULAR CUBIX LOCKERS

CUBIX

Stack Cubix lockers and easily attach adjacent units with pre-punched holes on top, sides and bottom. Or use the keyhole punched back for wall mounting. Ships Knock-Down ready-to-assemble,

- 3 Door types to choose from
- 3 Color choices
- 2 Handle/Lock choices



Safety-View Door with Key Cam Lock



Ventilated Diamond Perforated Locker Door



Plain Locker Door with Finger Pull Prepared for Padlock



Description	Overall Width	Overall Height	Overall Depth	Catalog No.	Color Selection
PREPARED FOR PADLOCK (NOT INCLUDED)					
Ventilated Door	11-5/16	12-11/16	12	HC121212-1DP	MB, ME, PL
Solid Door	11-5/16	12-11/16	12	HC121212-1PL	MB, ME, PL
Safety-View Plus Door	11-5/16	12-11/16	12	HC121212-1SVP	MB, ME, PL
WITH BUILT-IN KEY LOCK (INCLUDED)					
Ventilated Door	11-5/16	12-11/16	12	HC121212-1DP-K	MB, ME, PL
Solid Door	11-5/16	12-11/16	12	HC121212-1PL-K	MB, ME, PL
Safety-View Plus Door	11-5/16	12-11/16	12	HC121212-1SVP-K	MB, ME, PL



GENERAL SPECIFICATIONS

BODY CONSTRUCTION: Knock-down, 16 gauge

HINGES: 16 gauge continuous piano hinge

DOORS: 18 gauge Solid (non-vented), Diamond Perforated, or Safety-View (clear)

HANDLE/LOCKS: Single-point thru-the-door projecting Antimicrobial finger pull for protection against bacteria prepared for padlock (sold separately), or Built-in key lock

HOOKS: None

COAT RODS: None

SHELVES: None

LEGS: None



BACKPACK / LAPTOP LOCKERS

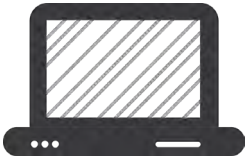

4-Tier
1-Wide
4 Openings



711
LIGHT GRAY (PL)

SPECIAL FEATURES:

- Each locker has built-in channel for concealed after-market wiring to convert lockers to charging stations.
- Channel shall include punch outs for electrical outlet in each opening. Wiring and outlets by others.

3-Tier
1-Wide
3 Openings

POWERED: Each locker has built-in channel for concealed after-market wiring to convert lockers to charging stations.

VENTILATED: Diamond perforated locker sides promote continuous air flow to cool chargers and components while keeping your items secure.

LOCK: Built-in Electronic Access Digitech lock - also acts as locker handle

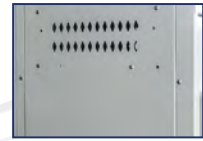

BACKPACK / LAPTOP LOCKERS

WIDTH	DEPTH	HEIGHT	GROUPING	OPENINGS	UNASSEMBLED CAT NO.	ASSEMBLED CAT NO.	COLOR SELECTION
3-TIER							
15	18	78	1-wide	3	UELBP1588-3PL	UELBP1588-3A-PL	PL
45	18	78	3-wide	9	UELBP3588-3PL	UELBP3588-3A-PL	PL
15	21	78	1-wide	3	UELBP1518-3PL	UELBP1518-3A-PL	PL
45	21	78	3-wide	9	UELBP3518-3PL	UELBP3518-3A-PL	PL
18	18	78	1-wide	3	UELBP1888-3PL	UELBP1888-3A-PL	PL
54	18	78	3-wide	9	UELBP3888-3PL	UELBP3888-3A-PL	PL
18	21	78	1-wide	3	UELBP1818-3PL	UELBP1818-3A-PL	PL
54	21	78	3-wide	9	UELBP3818-3PL	UELBP3818-3A-PL	PL
4-TIER							
15	18	78	1-wide	4	UELBP1588-4PL	UELBP1588-4A-PL	PL
45	18	78	3-wide	12	UELBP3588-4PL	UELBP3588-4A-PL	PL
15	21	78	1-wide	4	UELBP1518-4PL	UELBP1518-4A-PL	PL
45	21	78	3-wide	12	UELBP3518-4PL	UELBP3518-4A-PL	PL
18	18	78	1-wide	4	UELBP1888-4PL	UELBP1888-4A-PL	PL
54	18	78	3-wide	12	UELBP3888-4PL	UELBP3888-4A-PL	PL
18	21	78	1-wide	4	UELBP1818-4PL	UELBP1818-4A-PL	PL
54	21	78	3-wide	12	UELBP3818-4PL	UELBP3818-4A-PL	PL

GENERAL SPECIFICATIONS

BODY CONSTRUCTION: Knock down (KD) with 16 gauge solid top, bottom and intermediate shelves, 16 gauge perforated sides, 18 gauge solid back

DOORS: 14 gauge solid sheet steel

FRAME: 16 gauge welded frame

DOOR STRIKE: Continuous vertical door strike at both hinge and latch side

HANDLE: DigiTech™ electronic, code access lock serves as handle

LATCHING: Single-point cam latch

HINGES: 16 gauge continuous piano hinge

SHELVES: 1 fixed hat shelf per opening

HOOKS: none



MOBILE DEVICE LOCKERS



Prepared for Padlock



Keyed Cam Lock



Digitech™ H1 Electronic Locks



MOBILE DEVICE LOCKERS

OVERALL WIDTH	HEIGHT	DEPTH	GROUPING	OPENINGS PER GROUP	PADLOCK READY (PADLOCKS SOLD SEPARATELY) CAT NO.	WITH DIGITECH™ ELECTRONIC ACCESS LOCKS CAT NO.	WITH KEY CAM LOCK CAT NO.
9	30 1/2	12	1-wide	5	UCTL192(30)-5A	UCTL192(30)-5A-E	UCTL192(30)-5A-K
27	30 1/2	12	3-wide	15	UCTL392(30)-5A	UCTL392(30)-5A-E	UCTL392(30)-5A-K

CLEAR OPENING WIDTH	CLEAR OPENING HEIGHT	CLEAR OPENING DEPTH
7 1/2	5 1/2	11



711
LIGHT GRAY (PL)



GENERAL SPECIFICATIONS

BODY CONSTRUCTION: 20 gauge cold rolled steel

DOORS: 20 gauge solid (non-vented)

HANDLE/LOCKS Locks serve as door handle/pull

- **PADLOCK** Padlock hasp cam lock for padlocks by others
- **KEY LOCK** Cylinder cam locks
- **DIGITECH™ ELECTRONIC LOCK:** Pin code access electronic lock ships in temporary-use mode that can be programmed for permanent use

HINGES: 16 gauge continuous piano hinge

COAT RODS: None

SHELVES: None

HOOKS: None

LEGS: None



SUPERIOR
AMERICA'S MOST COMPLETE LOCKER LINE

SUPERIOR® BULK STORAGE LOCKERS



Superior® Bulk Storage Lockers are the most economical way to provide safe and secure storage in virtually any facility.

Choose from in-stock or custom sizes to fit your needs.



- ✓ **Single & Double Tier**
- ✓ **Economical**
- ✓ **Secure**
- ✓ **Durable**
- ✓ **Fast & Easy Installation**
- ✓ **Low Life-Cycle Cost**
- ✓ **Attractive**
- ✓ **User Friendly**

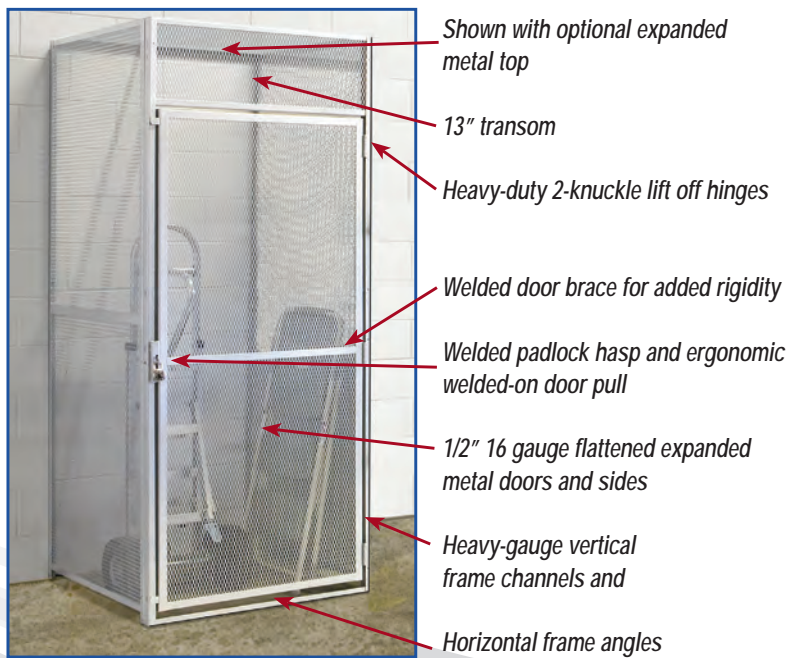

Single Tier Starter Unit

- Shown with optional expanded metal top
- 13" transom
- Heavy-duty 2-knuckle lift off hinges
- Welded door brace for added rigidity
- Welded padlock hasp and ergonomic welded-on door pull
- 1/2" 16 gauge flattened expanded metal doors and sides
- Heavy-gauge vertical frame channels and
- Horizontal frame angles



Optional 16 gauge 1/2" expanded metal top makes for a very secure structure adding rigidity and ensuring a higher level of protection from theft



The Heavy-Duty 2-knuckle lift off hinges and door stops are welded to the frame for extra strength and security of contents, imparting a more finished and attractive appearance to the unit.



Door handles are formed from one solid piece of steel and are welded to the frame for extra strength



711
DARK GRAY (HG)

NOTE: In the interest of safety, all lockers must be securely anchored to the floor and/or wall.

SUPERIOR® BULK STORAGE LOCKERS

Custom Installations

Superior® Bulk Storage Lockers' unique construction provides for a simple, easy way of handling interference from overhead pipes and/or ducts.

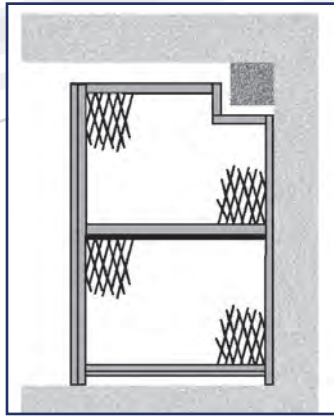

Showing cut out (with repair angles) to allow for interfering duct.

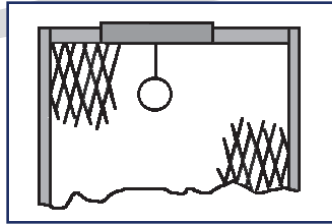

View of pipe through transom (or divider) with repair angle.

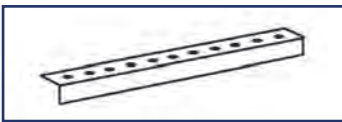

Repair Angles

REPAIR ANGLE 16 gauge 36" long repair angle is pre-punched on 2" centers to "heal" cuts in dividers or transom. Two bolts and clips are included with each angle.

Blue part number denotes in stock sizes. Custom sizes are also available.

BULK STORAGE LOCKER STOCK SIZES

Width 36" 48"
Depths 36" 48" 60"
Height 90"

Standard Sizes available in single and double tier configurations.

***Custom sizes are also available.**

OPTIONS

TOPS are recommended for situations where the ceiling height is 8'-6" or more when using standard 7'-6" high component modules.

SHELVES are used as dividers between top and bottom openings of double tier lockers. May also be used in single tier lockers for additional floor space and may be shorter than depth of locker to provide space for long items.

BACKS are required for back-to-back installations or where a single row is set away from a wall.

BOTTOMS are recommended for use on all single or double tier lockers if dampness prevails.

			STARTER UNITS		ADDER UNITS	
W	D	H	Part No. (Right Hinged)	Part No. (Left Hinged)	Part No. (Right Hinged)	Part No. (Left Hinged)
SINGLE TIER						
36	36	90	BSL363690-R-1S-HG	BSL363690-L-1S-HG	BSL363690-R-1A-HG	BSL363690-L-1A-HG
36	48	90	BSL364890-R-1S-HG	BSL364890-L-1S-HG	BSL364890-R-1A-HG	BSL364890-L-1A-HG
36	60	90	BSL366090-R-1S-HG	BSL366090-L-1S-HG	BSL366090-R-1A-HG	BSL366090-L-1A-HG
48	36	90	BSL483690-R-1S-HG	BSL483690-L-1S-HG	BSL483690-R-1A-HG	BSL483690-L-1A-HG
48	48	90	BSL484890-R-1S-HG	BSL484890-L-1S-HG	BSL484890-R-1A-HG	BSL484890-L-1A-HG
48	60	90	BSL486090-R-1S-HG	BSL486090-L-1S-HG	BSL486090-R-1A-HG	BSL486090-L-1A-HG
DOUBLE TIER						
36	36	45	BSL363690-R-2S-HG	BSL363690-L-2S-HG	BSL363690-R-2A-HG	BSL363690-L-2A-HG
36	48	45	BSL364890-R-2S-HG	BSL364890-L-2S-HG	BSL364890-R-2A-HG	BSL364890-L-2A-HG
36	60	45	BSL366090-R-2S-HG	BSL366090-L-2S-HG	BSL366090-R-2A-HG	BSL366090-L-2A-HG
48	36	45	BSL483690-R-2S-HG	BSL483690-L-2S-HG	BSL483690-R-2A-HG	BSL483690-L-2A-HG
48	48	45	BSL484890-R-2S-HG	BSL484890-L-2S-HG	BSL484890-R-2A-HG	BSL484890-L-2A-HG
48	60	45	BSL486090-R-2S-HG	BSL486090-L-2S-HG	BSL486090-R-2A-HG	BSL486090-L-2A-HG
ACCESSORIES FOR BULK STORAGE						
TOP PANELS						
36	36		4803636HG			
36	48		4803648HG			
36	60		4803660HG			
48	36		4804836HG			
48	48		4804848HG			
48	60		4804860HG			
FRONT EXTENSION PANELS						
6		90	4600690HG			
12		90	4601290HG			
18		90	4601890HG			
24		90	4602490HG			
BACK PANELS						
36		90	4703690HG			
48		90	4704890HG			
REPAIR ANGLES						
36			20100			

- **Single Tier:**
Overall Height 90"
Opening Height: 75-1/2"
- **Double Tier:**
Overall Height 90"
Upper Opening Height: 31-1/2"
Lower Opening Height: 42"
- **Doors:** available right-hand or left-hand hinged



24/7 PARCEL LOCKER LETS YOU RECEIVE AND PICK UP ANYTIME.

**24/7
PARCEL
LOCKER**

The locker features the NEW Hallowell DIGITECH™ H1 digital lock, a slimline ultra modern look and simple to operate.

Easily Manage Tenant Package Delivery

CONCIERGE...

1. Receives package for tenant
2. Places package in locker
3. Locks door using 4-digit PIN
4. Texts or emails Locker Number and PIN to Tenant

**TENANT, AT HIS/HER
CONVENIENCE...**

1. Enters PIN into lock of appropriate locker
2. Removes package
3. Closes door of now empty locker, PIN is erased

LOCKER FEATURES

- All-Welded Unibody Construction
- 14 Gauge solid steel doors with 16 Gauge piano hinge
- 16 Gauge solid steel body & 18 Gauge steel backs
- DigiTech H1 electronic locks
- Ships fully-assembled



711
LIGHT GRAY (PL)

POPULAR LOCKER CONFIGURATIONS



HEPL642-11
2-DOOR PARCEL LOCKER
36" x 24" x 72" Locker
(2) 18" x 72" doors



HEPL842-22
4-DOOR PARCEL LOCKER
36" x 24" x 72" Locker
(4) 18" x 36" doors



HEPL842-33
6-DOOR PARCEL LOCKER
36" x 24" x 72" Locker
(6) 18" x 24" doors



HEPL842-55
10-DOOR PARCEL LOCKER
36" x 24" x 72" Locker
(6) 18" x 8" doors above
(4) 18" x 24" doors at bottom



HEPL842-77
14-DOOR PARCEL LOCKER
36" x 24" x 72" Locker
(12) 18" x 8" doors above
(2) 18" x 24" doors at bottom



HEPL842-99
18-DOOR PARCEL LOCKER
36" x 24" x 72" Locker
(18) 18" x 8" doors



NEW DIGITECH H1 ELECTRONIC LOCKS

SECURITY CODE LOCK FEATURES

- 8-digit master and sub-master codes for two levels of management security.

CR123 LITHIUM BATTERY (INCLUDED)

- Provides over 10,000 normal uses.
- LED's Flash to indicate low battery level

MASTER KEY

- Locker can be opened with master key if batteries are exhausted.

PERMANENT MODE TOO

- User enters a pre-programmed 4-digit code to unlock and use locker repeatedly.



- Secure pop-out turn handle (flush when locked)

GENERAL SPECIFICATIONS

BODY: All-Welded Unibody Construction 16 gauge solid body with 18 ga backs

DOORS: 14 ga solid doors with 16 ga piano hinge

LOCKS: DigiTech horizontal electronic locks Ships fully-assembled, locks installed in field

COLOR: Light Gray (PL)

SUPERIOR® PORTABLE GATES



SUPERIOR® PORTABLE GATES ARE IDEAL FOR:

- SCHOOLS
- SHOPPING MALLS
- RECREATION CENTERS
- FACTORIES
- LIBRARIES
- HOSPITALS
- OFFICE BUILDINGS
- FINANCIAL INSTITUTIONS
- THEATERS
- MUSEUMS



SECURITY • TRAFFIC CONTROL • PORTABILITY

- In Stock for shipment within 5 days of receipt of order
- Quick and easy installation. Install between two walls instantly without anchors to walls or floor
- Simplified, patented pressure lock system
- Floor anchors are not required but are available for special installations
- Compact, fold-up size and heavy duty swivel casters make moving and storage easy
- Plated finish
- Padlock hasp is standard
- Cylinder locks are available for additional security
- Two or more gates can be joined together for large expanse

EXCLUSIVE SUPERIOR® PRESSURE LOCK

SYSTEM WORKS LIKE THIS:

1. Raise unit retainer channel to vertical position and secure
2. Extend gate until rubber bumpers touch both walls
3. Lower the male lock channel (with pin) until it rests on carriage channels within guides and locking bracket
4. Lower female lock channel (with adjustment holes) until it rests within the male lock channel with pin. Pin need not engage a hole in female lock channel
5. Raise both channels until pin engages the hole immediately to the right. Applying moderate pressure, push both channels down until they rest within guides and locking bracket. Lock in position

Five sizes to accommodate 3'-6" wide to 18'-0" wide conditions.

Connect multiple gates together for wider applications.

SUPERIOR® PORTABLE GATES				
Model	For Openings	Collapsed Size	Height	Weight (lbs)
P601-09	6'-0" to 9'-0"	19" x 30"	6'-6-1/2"	197
P601-12	7'-0" to 12'-0"	24" x 30"	6'-6-1/2"	254
P601-15	11'-0" to 15'-0"	30" x 30"	6'-6-1/2"	311
P601-18	13'-0" to 18'-0"	30" x 30"	6'-6-1/2"	374
PG-CL	Cylinder Locks			
PG-FAA	Floor Anchors			
PG-A	Additional Anchors			



SUPERIOR®
AMERICA'S MOST COMPLETE LOCKER LINE



- Custom Wood Lockers
- Sport Lockers
- Country Club Lockers
- Fitness Center Lockers
- Health Spa Lockers

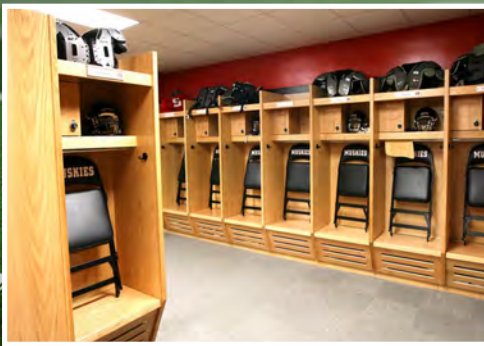

Ideal Choice for Your Next Wood Locker Project

Bring Prestige to your Organization with Custom Wood Lockers

Create a memorable environment for your current members, impress your potential members or dazzle day-use customers with Superior® Custom Recruiter Wood Lockers. Our lockers bring an upscale and luxurious design to your locker room with a very reasonable lifecycle cost.

We use the finest materials, and finish our lockers with a two coat, catalyzed, clear cabinet lacquer to keep the finish looking like new year-in and year-out. Each locker is hand crafted by expert craftsmen using state-of-the-art equipment to create an heirloom quality masterpiece.



Reinforce your commitment to your players!

RECRUITER SUPERIOR Wood Sport Lockers

Equip them with the industry's finest all-wood sport lockers. Superior[®] Recruiter™ custom wood sport lockers are made to order, and offer a

variety of different options allowing you to tailor your locker room to your team's specific requirements.

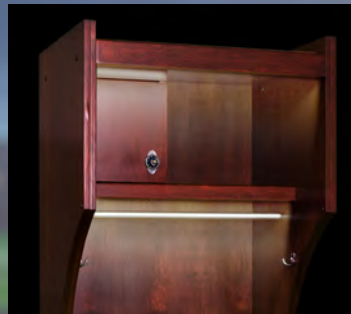

Optional LED Lighting under locker top and/or under shelf



Optional USB & 110 power outlet inside upper security box



Optional dual fan ventilation system for forced air ventilation of foot locker

Custom Wood Sport Lockers

In addition to our standard stock designs and sizes, our engineers are readily available to assist you in custom designing a locker to meet your specific needs. Be it a fitness center, team locker room,

country club or resort health spa, we stand behind our product with a full one year warranty that covers defects in materials and workmanship.

Five Side Options



Set Back Sides



Full Curve Sides



Standard Sides



Slant Sides



Half Curve Sides

Optional Features

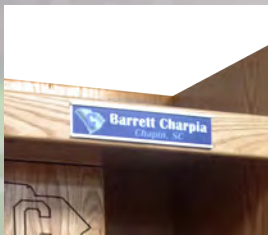

Name plate holders



Shoulder pad rack



Shoulder pad & Helmet rack



Foot locker front panel mesh insert



UV Full Color Print on security box door.



Padded Seat Cushion

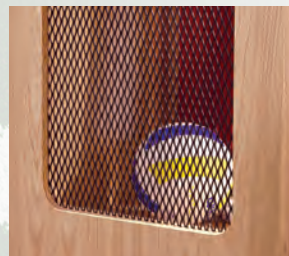

Optional mesh expanded metal side inserts for additional ventilation

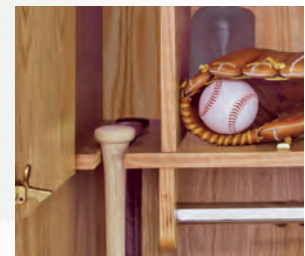

Optional Bat / Lacrosse Stick Caddy

LOCK OPTIONS: • Padlock • Built in combination lock • Mechanical lock • Electronic locks



**Introducing our New Recruiter™
Set-Back
QUICK-SHIP Design**

*The beauty is in the details...
These lockers are high quality fine furniture. We take special pride in
ensuring that each locker is a true work of art. All are made in our own
manufacturing plant and shipped directly to you.*

QUICK-SHIP LOCK OPTIONS

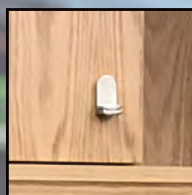

**STANDARD
PADLOCK CAM
HASP**



**BUILT IN
COMBINATION LOCK**

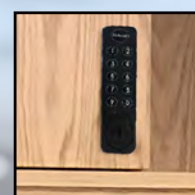

**DIGITECH-H1™
ELECTRONIC LOCK**



24" & 30" Wide Models Available From Quick-Ship

Stock Locker:
24" / 30" W x 24" D x 84" H
Starter Unit Shown
Includes Two Finished End Panels



RED OAK



OPTIONAL ADD ON ACCESSORIES

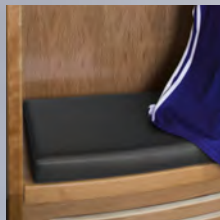

Seat Cushion (Black)
SC2424BK
SC3024BK

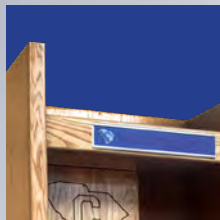

Name Plate Holder
NPH-0212S (12" wide)
NPH-0218S (18" wide)

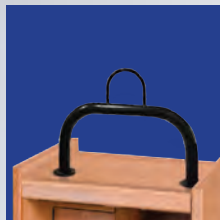

Shoulder Pad Rack
SPHR14R



Shoulder Pad & Helmet Rack
SPHR18R



USB Outlet in Security Box
USB-4
USB-4-110

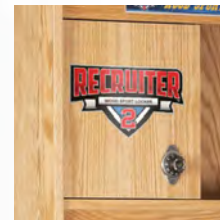

UV Full Color Print on security box door
RLDOORLOGO

ADDITIONAL QUICK-SHIP ACCESSORIES

- End Filler 15", RLEF1584
- Corner Filler 15" x 15", RLCF151584

OPTIONAL WOOD CHOICES ARE AVAILABLE.

Go to www.ListIndustries.com or Call 1-800-776-1342

(Additional Lead-time Apply)

SIDE PROFILE OPTIONS

(Additional Lead-time Apply)



STRAIGHT SLANT HALF CURVE FULL CURVE

WIDTH	DEPTH	HEIGHT	STARTER CAT. NO.	ADDER CAT. NO.
RECRUITER 2 WITH COMBINATION LOCK HASP				
24	24	84	R2SBS242484BNPLFSGRO-S	R2SBS242484BNPLFSGRO-A
RECRUITER 2 WITH BUILT IN COMBINATION LOCK				
24	24	84	R2SBS242484BNBCFSGRO-S	R2SBS242484BNBCFSGRO-A
RECRUITER 2 WITH DIGITECH™ H1 ELECTRONIC LOCK				
24	24	84	R2SBS242484BNDTFSGRO-S	R2SBS242484BNDTFSGRO-A
END FILLER PANELS				
15	-	84	RLEF1584	
CORNER FILLERS				
24	24	84	RLCF242484	
36	36	84	RLCF363684	

Starter units include (2) finished end panels to be used at row ends

Adder units do not include finished end panels

Order (1) Starter unit for each straight run of lockers and Adder units to fill out the run

FEATURES

- FURNITURE GRADE RED OAK HARDWOOD
Two Coats of Formaldehyde-Free Catalyzed Conversion Varnish for Excellent Moisture Resistance
- MODERN CONTOUR EDGES WITH WOOD EDGE BANDING
- UPPER SECURITY BOX
- THREE LOCK OPTIONS
- LOWER FOOT LOCKER/SEAT
- STAINLESS STEEL COAT ROD
- THREE STAINLESS STEEL HOOKS
- STARTER/ADDER UNIT CONFIGURATIONS
• 24" X 24" X 84" AND 30" X 24" X 84"
- SHIPS FULLY-ASSEMBLED
- INCLUDES TOE KICK MATERIAL
- 2 X 4 SUB-BASE BY OTHERS



SUPERIOR
AMERICA'S MOST COMPLETE LOCKER LINE



SOLID PLASTIC LOCKERS

Aquamax Solid Plastic Lockers are Ideal for applications where high humidity, moisture and water are present. Plastic lockers are fabricated from solid high density polyethylene panels (HDPE) for maximum strength and durability while providing corrosion resistance to most common chemicals.

AQUAMAX

HDPE PLASTIC LOCKERS

Mildew and Odor Resistant
Graffiti Resistant
Chemical Resistant

Completely Rust Proof



Available in single, double, triple, four, five, six and "Z" tier configurations

FEATURES

BODY CONSTRUCTION: Corrosion Proof High Density Polyethylene (HDPE), with 3/8" thick body panels

BODY STYLES: Single, double, triple, six tier and z-tier

HINGES: heavy-duty continuous full height extruded aluminum with a powder-coat finish to match color of door

HANDLE (Wardrobe): Projecting solid plastic handle with lift-type latching

HANDLE (Box): Single-point thru-the-door projecting friction catch door pull with padlock hasp

Z-Tier: Multi-height storage with extended hanging space



WARDROBE DOORS:
Projecting solid plastic handle with lift-type latching

STANDARD



BOX LOCKER DOORS:
Single-point thru-the-door projecting friction catch door pull with padlock hasp

AQUAMAX SIZES

MODEL	WIDTH	DEPTH	HEIGHT
1-Tier	12"	18"	72"
2-Tier	12"	18"	36" / 72"
3-Tier	12"	18"	24" / 72"
6-Tier	12"	18"	12" / 72"
Z-Tier	12"	18"	42" / 72"

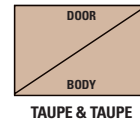

TAUPE & TAUPE



BLUE & TAUPE

FOR MORE INFO GO TO
LISTINDUSTRIES.COM

ANTIMICROBIAL HDPE PLASTIC LOCKERS



MedSafe AquaMax lockers are manufactured with high density polyethylene (HDPE), containing a specially formulated ANTIMICROBIAL agent that permanently resists the growth of bacteria, mold, yeast and mildew. This special feature, combined with all the great features of our AquaMax lockers, make these lockers ideal for use in medical, educational, retail and manufacturing environments.

HDPE contains a specially formulated antimicrobial agent that permanently resists the growth of bacteria, yeast and mildew.



1-Tier,
1 wide

2-Tier,
1 wide

Z-Tier,
1 wide

ANTIMICROBIAL PROTECTION FOR OVER 20 YEARS!

+MEDSAFE AQUAMAX SIZES

MODEL	WIDTH	DEPTH	HEIGHT
1-Tier	12"	18"	72"
2-Tier	12"	18"	36"/72"
Z-Tier	12"	18"	42"/72"

Available in single, double, and "Z" tier configurations

WHITE LOCKERS WITH
TAUPE HANDLES

WHITE
TAUPE HANDLES



FEATURES

BODY CONSTRUCTION: Corrosion Proof High Density Polyethylene (HDPE), with 3/8" thick body panels

BODY STYLES: Single, double, triple, six tier and z-tier

HINGES: heavy-duty continuous full height extruded aluminum with a powder-coat finish to match color of door

HANDLE (Wardrobe): Projecting solid plastic handle with lift-type latching

HANDLE (Box): Single-point thru-the-door projecting friction catch door pull with padlock hasp

SHELVES: Hat shelf is included in single tier lockers

HOOKS: 2 single-prong hooks in single and double tier lockers

SHELVES: Upper hat shelf and lower shelf included in single tier lockers 60" and 72" high

NOTES: All doors prepared for use with padlock (locks not included). Production locker body components are available in white only.

FOR MORE INFO GO TO
LISTINDUSTRIES.COM

SUPERIOR
AMERICA'S MOST COMPLETE LOCKER LINE

SOLID PHENOLIC LOCKERS

VERSAMAX

SOLID PHENOLIC LOCKERS

VersaMax™ Solid Phenolic lockers are engineered to the same high level of integrity found throughout our Superior® locker line.

The unique qualities of phenolic resin offer many value added benefits:

- ✓ **Environmentally Smart**
- ✓ **Moisture Resistant, perfect for wet or damp areas**
- ✓ **Mold and mildew resistant**
- ✓ **Many colors and finish options**
- ✓ **Laminate surface is graffiti and scratch resistant**



VERSASPORT

SOLID PHENOLIC LOCKERS



Phenolic Sport lockers are available in various standard styles designed to meet the needs of today's versatile athletes. Sport lockers can also be customized to meet your team's specific needs.

FOR MORE INFO GO TO
LISTINDUSTRIES.COM

SOLID PHENOLIC LOCKERS

Fully assembled single unit construction. End panels and filler panels are recommended for a finished installation. Designed with mortise & tenon joints, stainless steel fasteners and frame-less doors



See page 89 for color choices

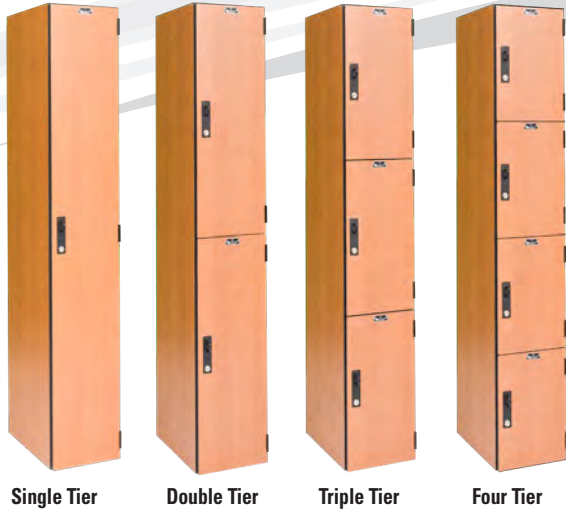

- **Single Tier** lockers are perfect for hanging of longer garments
- **Double Tier** lockers offer plenty of height for hanging coats and garments while using half the floor space of a single tier locker
- **Triple Tier** lockers are our most economical wardrobe locker allowing hanging garments to be draped from the coat hook
- **Four Tier** lockers provide ample storage for larger personal items like backpacks, totes, etc.

Various locking options:



Padlock Hasp

Electronic Locks

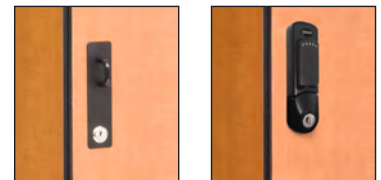

Built-In Key Locks

RFID Locks

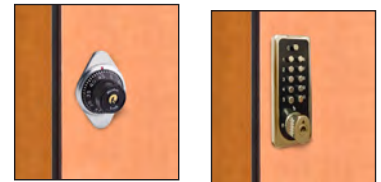

Built-In Combination Locks

Mechanical Shared Use Locks



Coin or Token Locks



STOCK COLOR
7284-58
FIGURED ANNIGRE



Five Tier

Six Tier



Z-Style

- **Five Tier** lockers are available in 12" and 14.4" high openings allowing for storage of personal belongings
- **Six Tier** lockers are our most economical storage solution offers storage of purses, bags, phones and other smaller personal items

- **Z-Style** Lockers are the perfect compromise between single and double tier lockers offering the perfect solution when space is at a premium, but hanging of longer garments is needed.

STOCK PHENOLIC LOCKER SIZES

Tier	Width	Depth	Opening Height	Overall Height
Single Tier	12	18	72	72
Double Tier	12	18	36	72
Six Tier	12	18	12	72
Z-Style	12	18	42	72

GENERAL SPECIFICATIONS

BODY CONSTRUCTION: Phenolic construction, Sides are 5/16" thick and backs are 1/4". Tops, bottoms and shelves are 3/8" thick.

DOORS: 1/2" thick solid phenolic with perimeter ventilation.

SHELVES: Hat shelf for single tier 60" & 72" lockers

STAINLESS STEEL COAT RODS: are optional for 1-Tier, 2-Tier, & Z-Style lockers 18" doors & deeper

PRODUCTION PHENOLIC LOCKER SIZES

Tier	Width	Depth	Opening Height	Overall Height
Single Tier	9", 12", 15", 18", 24"	12", 15", 18", 20", 24"	36", 48", 60", 72"	36", 48", 60", 72"
Double Tier	9", 12", 15", 18", 24"	12", 15", 18", 20"	18", 24", 30", 36"	36", 48", 60", 72"
Triple Tier	9", 12", 15", 18"	12", 15", 18", 20"	12", 20", 24"	36", 60", 72"
Four Tier	9", 12", 15", 18"	12", 15", 18", 20"	12", 15", 18"	48", 60", 72"
Five Tier	9", 12", 15", 18"	12", 15", 18", 20"	12", 14.4"	60", 72"
Six Tier	9", 12", 15", 18"	12", 15", 18", 20"	12"	72"
Z-Style	12", 15", 18"	12", 15", 18", 20"	36/24", 42", /30"	60", 72"
Sport	18", 24"	18", 20", 24"	N/A	72", 84"

SUPERIOR
 AMERICA'S MOST COMPLETE LOCKER LINE

INDUSTRIAL SHELVING

Hi-TECH™

Hallowell Industrial Grade Steel Shelving

Hi-Tech shelving is a complete shelving line with the strength needed to handle most industrial applications and versatility for today's modern facilities. Every shelving unit is designed and engineered to meet the highest standards.

A full complement of accessories including full dividers, partial dividers, label holders, swinging doors, post splices for multilevel systems and foot plates are available to complete your system.



**✓ IN STOCK
READY TO SHIP**

**5 DAY SHIPPING
ON ALL IN-STOCK
SHELVING**

**STOCK
COLORS**

725
DARK GRAY
(HG)

**FOR MORE INFO GO TO
LISTINDUSTRIES.COM**

**MADE IN
THE USA**



INDUSTRIAL SHELVING



BOX FORMED SHELVES

- Tubular welded box beam front and rear for maximum strength
- Exclusive triple bend side flanges for added strength
- Lapped and welded corners
- Top of shelf is punched to accept shelf dividers

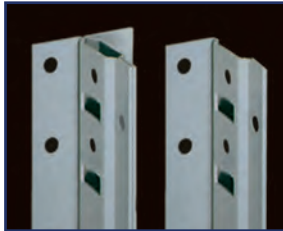

ANGLE BACK POSTS & T-POSTS

- Roll formed into a unique angle shape for maximum strength
- The long leg is punched on 1-1/2" centers to allow independent shelf adjustment
- Angle Posts can be used in place of Beaded Front Posts if desired



BEADED FRONT POSTS

- Beaded for strength
- Flush to permit straight-in/straight-out shelf installation, shelf changing and full use of shelf width
- Punched on 1-1/2" centers to allow independent shelf adjustment



H-POSTS

- Designed for high-density applications
- More than twice the capacity of standard posts
- Used at front and back
- Used with standard Hi-Tech components



ONE PIECE SHELF CLIP

- Four sturdy and compact clips per shelf
- Keys firmly into post slots to hold shelves securely in place
- Fits Beaded Front, Angle Back Posts and T-Posts
- Non-Intrusive clip sits flush with inside edge of front posts

Standard Shelving with Hi-Tech Shelves

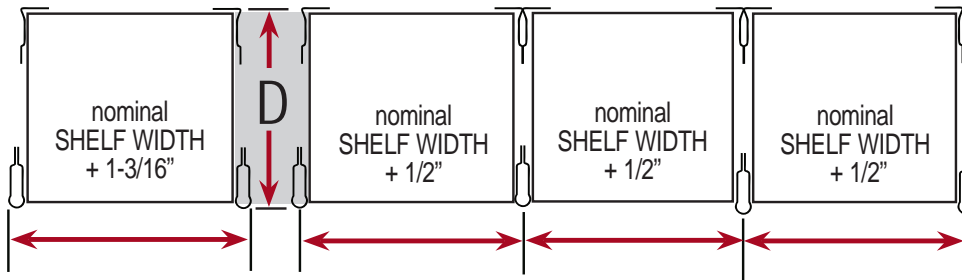

725
DARK GRAY
(HG)

PLUS ADD 3/4" PER ROW
FOR "D" - SINGLE FACE ADD 3/16" TO NOMINAL SHELF DEPTH
FOR "D" - DOUBLE FACE ADD 3/8" TO NOMINAL SHELF DEPTH



ACCESSORIES

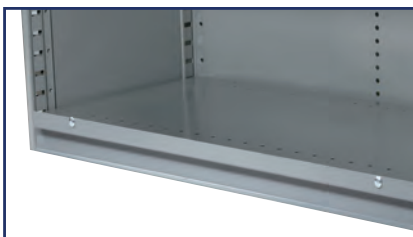

Base Strips
Close bottom to prevent debris accumulation



Swinging Doors
Allow cabinet-style storage



Shelf Dividers
For organized storage

SUPERIOR
AMERICA'S MOST COMPLETE LOCKER LINE

Hallowell Industrial Grade Steel Shelving

OPEN



STARTER UNIT



ADDER UNIT



5 SHELF UNIT



6 SHELF UNIT



8 SHELF UNIT

OPEN SHELVING MEDIUM, HEAVY AND EXTRA HEAVY-DUTY

W	D	H		5-Shelf Unit Cat No.	6-Shelf Unit Cat No.	8-Shelf Unit Cat No.	Shelf Capacity*
MEDIUM-DUTY							
36	12	87	Starter	4510-12	4511-12	4513-12	500*
36	12	87	Adder	A4510-12	A4511-12	A4513-12	500*
36	18	87	Starter	4510-18	4511-18	4513-18	500*
36	18	87	Adder	A4510-18	A4511-18	A4513-18	500*
36	24	87	Starter	4510-24	4511-24	4513-24	500*
36	24	87	Adder	A4510-24	A4511-24	A4513-24	500*
48	12	87	Starter	4710-12	4711-12	4713-12	375*
48	12	87	Adder	A4710-12	A4711-12	A4713-12	375*
48	18	87	Starter	4710-18	4711-18	4713-18	375*
48	18	87	Adder	A4710-18	A4711-18	A4713-18	375*
48	24	87	Starter	4710-24	4711-24	4713-24	350*
48	24	87	Adder	A4710-24	A4711-24	A4713-24	350*
HEAVY-DUTY							
36	12	87	Starter	5510-12	5511-12	5513-12	800*
36	12	87	Adder	A5510-12	A5511-12	A5513-12	800*
36	18	87	Starter	5510-18	5511-18	5513-18	800*
36	18	87	Adder	A5510-18	A5511-18	A5513-18	800*
36	24	87	Starter	5510-24	5511-24	5513-24	800*
36	24	87	Adder	A5510-24	A5511-24	A5513-24	800*
48	12	87	Starter	5710-12	5711-12	5713-12	400*
48	12	87	Adder	A5710-12	A5711-12	A5713-12	400*
48	18	87	Starter	5710-18	5711-18	5713-18	450*
48	18	87	Adder	A5710-18	A5711-18	A5713-18	450*
48	24	87	Starter	5710-24	5711-24	5713-24	500*
48	24	87	Adder	A5710-24	A5711-24	A5713-24	500*
EXTRA HEAVY-DUTY							
36	12	87	Starter	7510-12	7511-12	7513-12	1100*
36	12	87	Adder	A7510-12	A7511-12	A7513-12	1100*
36	18	87	Starter	7510-18	7511-18	7513-18	1200*
36	18	87	Adder	A7510-18	A7511-18	A7513-18	1200*
36	24	87	Starter	7510-24	7511-24	7513-24	1250*
36	24	87	Adder	A7510-24	A7511-24	A7513-24	1250*
48	12	87	Starter	7710-12	7711-12	7713-12	750*
48	12	87	Adder	A7710-12	A7711-12	A7713-12	750*
48	18	87	Starter	7710-18	7711-18	7713-18	900*
48	18	87	Adder	A7710-18	A7711-18	A7713-18	900*
48	24	87	Starter	7710-24	7711-24	7713-24	900*
48	24	87	Adder	A7710-24	A7711-24	A7713-24	900*

Additional Shelves		Medium-Duty Cat No	Heavy-Duty Cat No.	Extra Heavy-Duty Cat No.	
36	12	5135-3612	5138-3612	5139-3612	See Above
36	18	5135-3618	5138-3618	5139-3618	See Above
36	24	5135-3624	5138-3624	5139-3624	See Above
48	12	5135-4812	5138-4812	5139-4812	See Above
48	18	5135-4818	5138-4818	5139-4818	See Above
48	24	5135-4824	5138-4824	5139-4824	See Above

Blue part number denotes in stock sizes.



725
DARK GRAY
(HG)

* Shelf capacities include 1.65 safety factor
Color for all components 725 DARK GRAY. Optional colors are available at a nominal charge, additional lead times apply.

Open units: Starter units include two beaded front posts, two angle back posts, one pair back sway braces, two pair side sway braces and 5-8 shelves. Adder units include one beaded front post, two angle back posts, one pair back sway braces, one pair side sway braces and 5-8 shelves.

CLOSED

CLOSED SHELVING MEDIUM, HEAVY AND EXTRA HEAVY-DUTY

W	D	H		5-Shelf Unit Cat No.	6-Shelf Unit Cat No.	8-Shelf Unit Cat No.	Shelf Capacity*
MEDIUM-DUTY							
36	12	87	Starter	4520-12	4521-12	4523-12	500*
36	12	87	Adder	A4520-12	A4521-12	A4523-12	500*
36	18	87	Starter	4520-18	4521-18	4523-18	500*
36	18	87	Adder	A4520-18	A4521-18	A4523-18	500*
36	24	87	Starter	4520-24	4521-24	4523-24	500*
36	24	87	Adder	A4520-24	A4521-24	A4523-24	500*
48	12	87	Starter	4720-12	4721-12	4723-12	375*
48	12	87	Adder	A4720-12	A4721-12	A4723-12	375*
48	18	87	Starter	4720-18	4721-18	4723-18	375*
48	18	87	Adder	A4720-18	A4721-18	A4723-18	375*
48	24	87	Starter	4720-24	4721-24	4723-24	350*
48	24	87	Adder	A4720-24	A4721-24	A4723-24	350*
HEAVY-DUTY							
36	12	87	Starter	5520-12	5521-12	5523-12	800*
36	12	87	Adder	A5520-12	A5521-12	A5523-12	800*
36	18	87	Starter	5520-18	5521-18	5523-18	800*
36	18	87	Adder	A5520-18	A5521-18	A5523-18	800*
36	24	87	Starter	5520-24	5521-24	5523-24	800*
36	24	87	Adder	A5520-24	A5521-24	A5523-24	800*
48	12	87	Starter	5720-12	5721-12	5723-12	400*
48	12	87	Adder	A5720-12	A5721-12	A5723-12	400*
48	18	87	Starter	5720-18	5721-18	5723-18	450*
48	18	87	Adder	A5720-18	A5721-18	A5723-18	450*
48	24	87	Starter	5720-24	5721-24	5723-24	500*
48	24	87	Adder	A5720-24	A5721-24	A5723-24	500*
EXTRA HEAVY-DUTY							
36	12	87	Starter	7520-12	7521-12	7523-12	1100*
36	12	87	Adder	A7520-12	A7521-12	A7523-12	1100*
36	18	87	Starter	7520-18	7521-18	7523-18	1200*
36	18	87	Adder	A7520-18	A7521-18	A7523-18	1200*
36	24	87	Starter	7520-24	7521-24	7523-24	1250*
36	24	87	Adder	A7520-24	A7521-24	A7523-24	1250*
48	12	87	Starter	7720-12	7721-12	7723-12	750*
48	12	87	Adder	A7720-12	A7721-12	A7723-12	750*
48	18	87	Starter	7720-18	7721-18	7723-18	900*
48	18	87	Adder	A7720-18	A7721-18	A7723-18	900*
48	24	87	Starter	7720-24	7721-24	7723-24	900*
48	24	87	Adder	A7720-24	A7721-24	A7723-24	900*



STARTER UNIT



ADDER UNIT



5 SHELF UNIT



6 SHELF UNIT



8 SHELF UNIT

Additional Shelves	Medium-Duty Cat No.	Heavy-Duty Cat No.	Extra Heavy-Duty Cat No.	
36 12	5135-3612	5138-3612	5139-3612	See Above
36 18	5135-3618	5138-3618	5139-3618	See Above
36 24	5135-3624	5138-3624	5139-3624	See Above
48 12	5135-4812	5138-4812	5139-4812	See Above
48 18	5135-4818	5138-4818	5139-4818	See Above
48 24	5135-4824	5138-4824	5139-4824	See Above



* Shelf capacities include 1.65 safety factor
Color for all components 725 DARK GRAY. Optional colors are available at a nominal charge, additional lead times apply.

Closed units: Starter units include two beaded front posts, two angle back posts, one back panel assembly, two side panel assemblies and 5-8 shelves. Adder units include one beaded front post, two angle back posts, one back panel assembly, one side assembly and 5-8 shelves.

DURATECH™

NO CROSS BRACES

PASS-THRU STEEL SHELVING

QUICKSHIP

Heavy-Duty Industrial Grade Steel Shelving

DuraTech, Hallowell's newest line of pass-thru steel shelving, does not require cross braces, allowing access from all sides while providing the maximum strength, durability and stability needed to handle most industrial applications. DuraTech offers versatility and durability for today's modern facilities.

Our complete line of shelving is designed and engineered to the highest standards.

FEATURES

- Access from all 4 sides.
- Top and bottom firmly attached with steel-grip nuts for superior strength
- Available in 5, 7 and 8 shelf models.
- Four angle posts are used per section allowing units to be individually located, bolted side-by-side or bolted back-to-back.
- Each intermediate shelf uses four sturdy and compact clips.
- Clips key firmly into post slots to hold shelves securely in place.
- Provides independent positioning of intermediate shelves on 1-1/2" centers.
- Bottom shelf is positioned to prevent debris from collecting beneath unit.

STOCK COLOR

DARK GRAY (HG)

MADE IN THE USA

FOR MORE INFO GO TO LISTINDUSTRIES.COM

**360° Access - No Cross Braces
Creates a more efficient storage system!**

Our Unique Grip Nut Design Creates A Very Strong And Rigid Structure

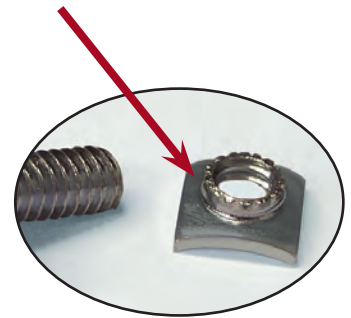

UL GREENGUARD GOLD CERTIFIED

QUICKSHIP

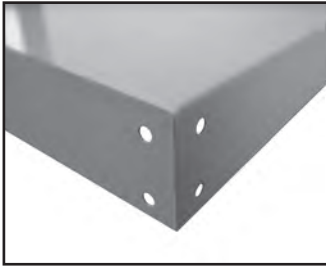

Top and bottom shelves attach with bolts at each corner providing a strong and rigid structure



Bottom shelf is positioned to prevent debris from collecting beneath unit



Top and bottom shelves are triple flanged at all four sides and bolted to angle posts at all four corners for maximum rigidity, durability and stability.



Angle posts are roll formed into a unique angle shape for maximum strength. Leg is punched on 1-1/2" centers to allow independent intermediate shelf adjustment



Intermediate shelves have a tubular flange at the front and rear, and exclusive triple bend sides for added strength.



Compression Shelf Clip for intermediate shelves

Fully Adjustable Intermediate Shelves with fixed top and bottom for a strong unit That DOES NOT require CROSS Braces



5-SHELF UNIT
3-adjustable shelves



7-SHELF UNIT
5-adjustable shelves



8-SHELF UNIT
6-adjustable shelves

W	D	H	* Capacity Per Shelf	5-Shelf Catalog No.	7-Shelf Catalog No.	8-Shelf Catalog No.
36" WIDE UNITS						
36	12	87	800	DT5510-12	DT5512-12	DT5513-12
36	18	87	800	DT5510-18	DT5512-18	DT5513-18
36	24	87	800	DT5510-24	DT5512-24	DT5513-24
48" WIDE UNITS						
48	12	87	400	DT5710-12	DT5712-12	DT5713-12
48	18	87	450	DT5710-18	DT5712-18	DT5713-18
48	24	87	500	DT5710-24	DT5712-24	DT5713-24

All Units Include: Four angle posts, two DuraTech bolt-in shelves to be used at unit top and bottom and intermediate adjustable shelves with shelf clips applicable to unit ordered. All DuraTech shelving units are free standing and can be joined end-to-end or back-to-back.

BOLTLESS STEEL SHELVING

Boltless shelving is designed to maximize storage space and minimize installation set-up time.

All components are engineered to attach snugly to one another without the use of loose fasteners. Pre-attached rivets to all left-to-right and front-to-back beams align with keyhole slots in the vertical posts. Once tapped into place the units are tightly assembled providing maximum strength.

Standard units consist of vertical angle posts, double rivet angle beams at the top and bottom perimeter, and single rivet angle beams running left-to-right only at the intermediate levels. Shelves are of standard 5/8" particle board, EZ-Deck steel or wire decking and simply drop into place. Shelving strength can be increased by upgrading to heavy duty beams and posts, see page 67



Double Rivet unit with 5 levels

The versatility of our Rivetwell boltless shelving system allows you to mix and match components to meet your unique application. From standard storage applications, record storage to automotive tire racks, Rivetwell boltless shelving is your storage solution.

FOR MORE INFO GO TO LISTINDUSTRIES.COM



Single Rivet unit with 5 levels

Double Rivet unit with 4 levels

EASY ASSEMBLY

STOCK COLOR

729 TAN (PT)

MADE IN THE USA

BOLTLESS STEEL SHELVING

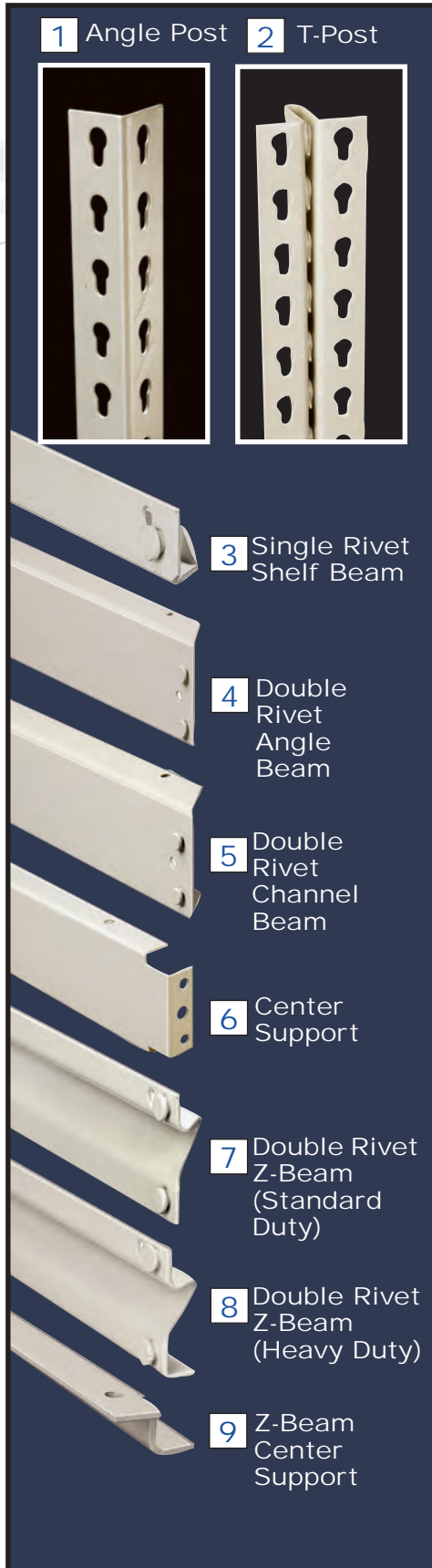

1 Angle Post 2 T-Post



3 Single Rivet Shelf Beam

4 Double Rivet Angle Beam

5 Double Rivet Channel Beam

6 Center Support

7 Double Rivet Z-Beam (Standard Duty)

8 Double Rivet Z-Beam (Heavy Duty)

9 Z-Beam Center Support

1 ANGLE POST (STANDARD DUTY): 1-1/2" x 1-1/2" x 14 gauge cold rolled steel corner post uprights. Perfect for standard load situations.

ANGLE POST (HEAVY DUTY): Shall be 1-7/8" x 1-7/8" x 14 gauge cold rolled steel uprights. The choice when heavy duty shelving is required. Perfect for multilevel installations.

2 T-POST (STANDARD DUTY): 3" x 1-7/8" x 14 gauge cold rolled steel intermediate uprights.

T-POST (HEAVY DUTY): 3-3/4" x 1-7/8" x 14 gauge cold rolled steel intermediate uprights.

3 SINGLE RIVET SHELF BEAM (STANDARD DUTY): This 14 gauge low profile standard intermediate level shelf beam is perfect when maximum clear opening is required between shelf levels.

SINGLE RIVET SHELF BEAM (HEAVY DUTY): An 11 gauge heavy duty version of our low profile intermediate shelf beam allowing maximum clear opening between shelf levels.

4 DOUBLE RIVET ANGLE BEAM (STANDARD DUTY): This 16 gauge shelf beam is essential for stability of standard units; therefore, is used on all four sides at the top and bottom levels. Can also be used front and back or on all four sides of intermediate levels to increase unit stability and load capacity.

DOUBLE RIVET ANGLE BEAM (HEAVY DUTY): An upgrade to our standard duty double rivet angle beams, our heavy duty double rivet angle beams provide additional unit rigidity and even higher shelf capacity.

5 DOUBLE RIVET CHANNEL BEAM: Maximized left-to-right shelf capacity is achieved using our 14 gauge double rivet channel beams in lieu of double rivet angle beams. These beams cannot be used at the bottom level.

6 CENTER SUPPORT: Used to provide additional shelf support front-to-back by bolting between double rivet beams at prepunched locations. Ideal for wider spans.

7 DOUBLE RIVET Z-BEAM (STANDARD DUTY): For 12" thru 60" beams. Used in place of double rivet angle beams to add 1" additional clearance between shelf levels. Allows particle board decking to sit flush with beam. Protects decking edges. When used at bottom level of single rivet units, shelf clearance is increased by 1" at lower level. Standard Z beams are 14 gauge.

8 DOUBLE RIVET Z-BEAM (HEAVY DUTY): For 69" and 72" beams. Used in place of double rivet angle beams to add 1" additional clearance between shelf levels. Allows particle board decking to sit flush with beam. Protects decking edges. Heavy-Duty Z beams are 14 gauge.

9 CENTER SUPPORT FOR Z-BEAM: Used with Z-Beams for front to back decking support. Fabricated of 11 gauge cold rolled steel.

UNIT GROWTH CHART

When designing a shelving layout, unit growth must be considered. To determine the overall dimension of a continuous row of shelving employing T-Posts or Angle Posts with tie plates, refer to the table below.

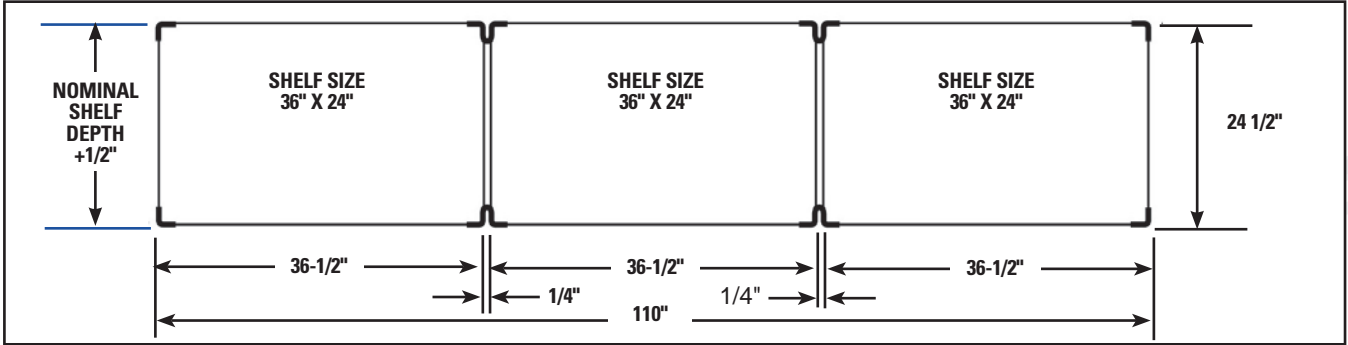

UNIT CLEAR WIDTH

Examples below are based on 36" wide shelf.

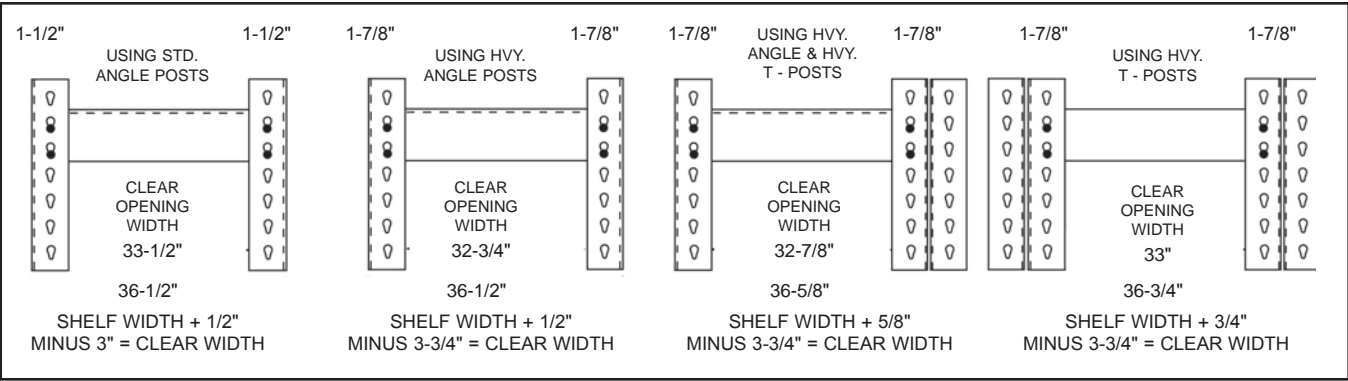

VERTICAL SHELF CLEARANCE FOR SINGLE RIVET UNITS

This chart depicts shelf clearances for typical rivetwell shelving units with 1-1/2" vertical shelf adjustment

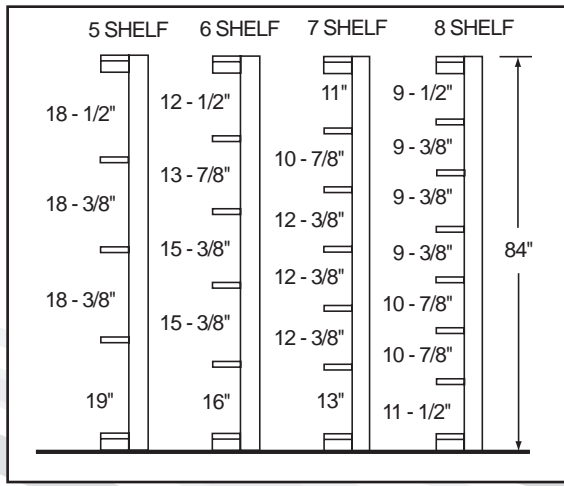

VERTICAL SHELF CLEARANCE FOR DOUBLE RIVET UNITS

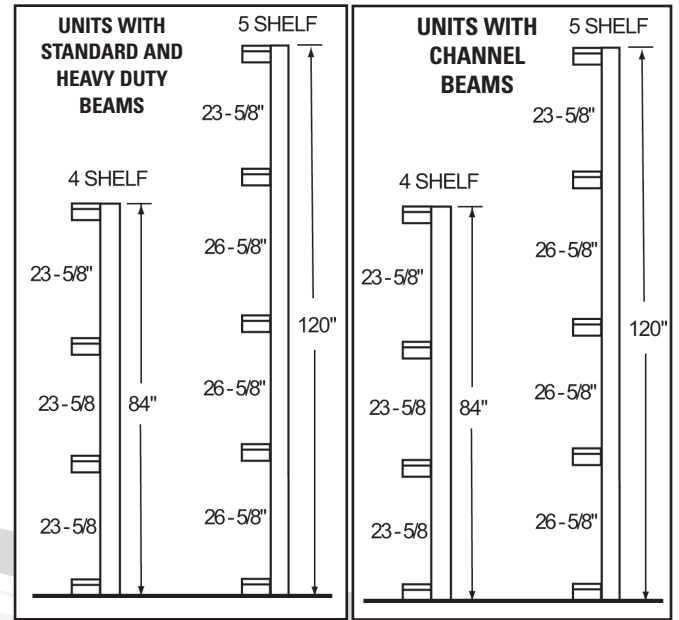

BOLTLESS STEEL SHELVING

SINGLE RIVET UNITS - 84" HIGH							
36" Wide Units (Decking not included)					48" Wide Units (Decking not included)		
Levels	Depth	Shelf Capacity	Starter Model No.	Adder Model No.	Shelf Capacity	Starter Model No.	Adder Model No.
5 Shelf	12	350	SRS361284-5S	SRS361284-5A	250	SRS481284-5S	SRS481284-5A
Units	18	350	SRS361884-5S	SRS361884-5A	250	SRS481884-5S	SRS481884-5A
	24	350	SRS362484-5S	SRS362484-5A	250	SRS482484-5S	SRS482484-5A
	30	350	SRS363084-5S	SRS363084-5A	250	SRS483084-5S	SRS483084-5A
	36	350	SRS363684-5S	SRS363684-5A	250	SRS483684-5S	SRS483684-5A
	6 Shelf	12	350	SRS361284-6S	SRS361284-6A	250	SRS481284-6S
Units	18	350	SRS361884-6S	SRS361884-6A	250	SRS481884-6S	SRS481884-6A
	24	350	SRS362484-6S	SRS362484-6A	250	SRS482484-6S	SRS482484-6A
	30	350	SRS363084-6S	SRS363084-6A	250	SRS483084-6S	SRS483084-6A
	36	350	SRS363684-6S	SRS363684-6A	250	SRS483684-6S	SRS483684-6A
	7 Shelf	12	350	SRS361284-7S	SRS361284-7A	250	SRS481284-7S
Unit	18	350	SRS361884-7S	SRS361884-7A	250	SRS481884-7S	SRS481884-7A
	24	350	SRS362484-7S	SRS362484-7A	250	SRS482484-7S	SRS482484-7A
	30	350	SRS363084-7S	SRS363084-7A	250	SRS483084-7S	SRS483084-7A
	36	350	SRS363684-7S	SRS363684-7A	250	SRS483684-7S	SRS483684-7A
	8 Shelf	12	350	SRS361284-8S	SRS361284-8A	250	SRS481284-8S
Unit	18	350	SRS361884-8S	SRS361884-8A	250	SRS481884-8S	SRS481884-8A
	24	350	SRS362484-8S	SRS362484-8A	250	SRS482484-8S	SRS482484-8A
	30	350	SRS363084-8S	SRS363084-8A	250	SRS483084-8S	SRS483084-8A
	36	350	SRS363684-8S	SRS363684-8A	250	SRS483684-8S	SRS483684-8A

STARTER UNITS consist of four standard angle posts, four left-to-right standard double rivet angle beams, four front-to-back standard double rivet angle beams, two left-to-right standard single rivet beams per intermediate level and two front-to-back standard single rivet beam at one intermediate level only (30" and 36" deep units include two front-to-back single rivet beams at each intermediate level).

ADDER UNITS consist of two standard T-Posts, four left-to-right standard double rivet angle beams, two front-to-back standard double rivet angle beam, two left-to-right standard single rivet beam per intermediate level and one front-to-back standard single rivet beam at one intermediate level only (30" and 36" deep units include one front-to-back single rivet beam at each intermediate level).

PARTICLE BOARD DECKING	
SIZE	PART NO.
36" X 12"	HPB3612
36" X 18"	HPB3618
36" X 24"	HPB3624
36" X 30"	HPB3630
36" X 36"	HPB3636
48" X 12"	HPB4812
48" X 18"	HPB4818
48" X 24"	HPB4824
48" X 30"	HPB4830
48" X 36"	HPB4836

Be sure to order one each of particle board decking per level. EZ-Deck steel decking can NOT be used on single rivet units.



Standard 5-shelf single rivet unit (order decking separately)

Standard 4-shelf double rivet unit (order decking separately)



729
TAN (PT)

DOUBLE RIVET UNITS - 84" HIGH WITH 4 LEVELS

Width	Beam Type	Depth	Without Center Support (Decking Not Included)			With Center Support (Decking Not Included)			Decking	
			Shelf Cap	Starter Model No.	Adder Model No.	Shelf Cap	Starter Model No.	Adder Model No.	Particle Board Decking	EZ-Deck Steel Decking
48"	Standard Angle Beam	18	550	DRS481884-4S	DRS481884-4A	875	DRSC481884-4S	DRSC481884-4A	HPB4818	HEZD4818
		24	550	DRS482484-4S	DRS482484-4A	875	DRSC482484-4S	DRSC482484-4A	HPB4824	HEZD4824
		30	550	DRS483084-4S	DRS483084-4A	825	DRSC483084-4S	DRSC483084-4A	HPB4830	HEZD4830
		36	550	DRS483684-4S	DRS483684-4A	775	DRSC483684-4S	DRSC483684-4A	HPB4836	HEZD4836
		48	550	DRS484884-4S	DRS484884-4A	700	DRSC484884-4S	DRSC484884-4A	HPB4848	HEZD4848
48"	Heavy-Duty Angle	18	750	DRH481884-4S	DRH481884-4A	1400	DRHC481884-4S	DRHC481884-4A	HPB4818	HEZD4818
		24	750	DRH482484-4S	DRH482484-4A	1400	DRHC482484-4S	DRHC482484-4A	HPB4824	HEZD4824
		30	750	DRH483084-4S	DRH483084-4A	1310	DRHC483084-4S	DRHC483084-4A	HPB4830	HEZD4830
		36	750	DRH483684-4S	DRH483684-4A	1220	DRHC483684-4S	DRHC483684-4A	HPB4836	HEZD4836
		48	750	DRH484884-4S	DRH484884-4A	1125	DRHC484884-4S	DRHC484884-4A	HPB4848	HEZD4848
60"	Heavy-Duty Angle Beam	18	600	DRH601884-4S	DRH601884-4A	1200	DRHC601884-4S	DRHC601884-4A	HPB6018	HEZD6018
		24	600	DRH602484-4S	DRH602484-4A	1200	DRHC602484-4S	DRHC602484-4A	HPB6024	HEZD6024
		30	600	DRH603084-4S	DRH603084-4A	1200	DRHC603084-4S	DRHC603084-4A	HPB6030	HEZD6030
		36	600	DRH603684-4S	DRH603684-4A	1200	DRHC603684-4S	DRHC603684-4A	HPB6036	HEZD6036
		48	600	DRH604884-4S	DRH604884-4A	1200	DRHC604884-4S	DRHC604884-4A	HPB6048	HEZD6048
60"	Channel Beam	18	-	-	-	2000	DRCC601884-4S	DRCC601884-4A	HPB6018	HEZD6018
		24	-	-	-	2000	DRCC602484-4S	DRCC602484-4A	HPB6024	HEZD6024
		30	-	-	-	2000	DRCC603084-4S	DRCC603084-4A	HPB6030	HEZD6030
		36	-	-	-	2000	DRCC603684-4S	DRCC603684-4A	HPB6036	HEZD6036
		48	-	-	-	2000	DRCC604884-4S	DRCC604884-4A	HPB6048	HEZD6048
72"	Heavy-Duty Angle Beam	18	500	DRH721884-4S	DRH721884-4A	1000	DRHC721884-4S	DRHC721884-4A	HPB7218	HEZD7218
		24	500	DRH722484-4S	DRH722484-4A	1000	DRHC722484-4S	DRHC722484-4A	HPB7224	HEZD7224
		30	500	DRH723084-4S	DRH723084-4A	1000	DRHC723084-4S	DRHC723084-4A	HPB7230	HEZD7230
		36	500	DRH723684-4S	DRH723684-4A	1000	DRHC723684-4S	DRHC723684-4A	HPB7236	HEZD7236
		48	500	DRH724884-4S	DRH724884-4A	1000	DRHC724884-4S	DRHC724884-4A	HPB7248	HEZD7248
72"	Channel Beam	18	-	-	-	1850	DRCC721884-4S	DRCC721884-4A	HPB7218	HEZD7218
		24	-	-	-	1850	DRCC722484-4S	DRCC722484-4A	HPB7224	HEZD7224
		30	-	-	-	1850	DRCC723084-4S	DRCC723084-4A	HPB7230	HEZD7230
		36	-	-	-	1850	DRCC723684-4S	DRCC723684-4A	HPB7236	HEZD7236
		48	-	-	-	1850	DRCC724884-4S	DRCC724884-4A	HPB7248	HEZD7248
96"	Heavy-Duty Angle Beam	18	-	-	-	620	DRHC961884-4S	DRHC961884-4A	HPB9618	HEZD9618
		24	-	-	-	620	DRHC962484-4S	DRHC962484-4A	HPB9624	HEZD9624
		30	-	-	-	620	DRHC963084-4S	DRHC963084-4A	HPB9630	HEZD9630
		36	-	-	-	620	DRHC963684-4S	DRHC963684-4A	HPB9636	HEZD9636
		48	-	-	-	620	DRHC964884-4S	DRHC964884-4A	HPB9648	HEZD9648
96"	Channel Beam	18	-	-	-	1400	DRCC961884-4S	DRCC961884-4A	HPB9618	HEZD9618
		24	-	-	-	1400	DRCC962484-4S	DRCC962484-4A	HPB9624	HEZD9624
		30	-	-	-	1400	DRCC963084-4S	DRCC963084-4A	HPB9630	HEZD9630
		36	-	-	-	1400	DRCC963684-4S	DRCC963684-4A	HPB9636	HEZD9636
		48	-	-	-	1400	DRCC964884-4S	DRCC964884-4A	HPB9648	HEZD9648

DOUBLE RIVET UNITS - 120" HIGH WITH 5 LEVELS

72"	Heavy-Duty Angle Beam	30	500	DRH7230120-5S	DRH7230120-5A	1000	DRHC7230120-5S	DRHC7230120-5A	HPB7230	HEZD7230
		36	500	DRH7236120-5S	DRH7236120-5A	1000	DRHC7236120-5S	DRHC7236120-5A	HPB7236	HEZD7236
		48	500	DRH7248120-5S	DRH7248120-5A	1000	DRHC7248120-5S	DRHC7248120-5A	HPB7248	HEZD7248
72"	Channel Beam	30	-	-	-	1490	DRCC7230120-5S	DRCC7230120-5A	HPB7230	HEZD7230
		36	-	-	-	1490	DRCC7236120-5S	DRCC7236120-5A	HPB7236	HEZD7236
		48	-	-	-	1490	DRCC7248120-5S	DRCC7248120-5A	HPB7248	HEZD7248
96"	Heavy-Duty Angle Beam	30	-	-	-	620	DRHC9630120-5S	DRHC9630120-5A	HPB9630	HEZD9630
		36	-	-	-	620	DRHC9636120-5S	DRHC9636120-5A	HPB9636	HEZD9636
		48	-	-	-	620	DRHC9648120-5S	DRHC9648120-5A	HPB9648	HEZD9648
96"	Channel Beam	30	-	-	-	1400	DRCC9630120-5S	DRCC9630120-5A	HPB9630	HEZD9630
		36	-	-	-	1400	DRCC9636120-5S	DRCC9636120-5A	HPB9636	HEZD9636
		48	-	-	-	1400	DRCC9648120-5S	DRCC9648120-5A	HPB9648	HEZD9648

Starter units consist of four standard angle posts, *two left-to-right standard double rivet angle/channel beams per level and two front-to-back standard double rivet angle beams per level.

Adder units consist of two standard T-Posts, *two left-to-right standard double rivet angle/channel beams per level and two front-to-back standard double rivet angle beams per level. *Channel beam units are provided with left-to-right double rivet angle beams at bottom level.

BOLTLESS STEEL SHELVING

RECORD STORAGE UNITS								
Width	Depth	Height	Levels	No. of boxes	Starter Model No.	Adder Model No.	Particle Board Decking	EZ-Deck Steel Decking
42"	15"	60"	3	18	RS421560-3S	RS421560-3A	HPB4215	HEZD4215
	30"	60"	3	36	RS423060-3S	RS423060-3A	HPB4230	HEZD4230
69"	15"	60"	3	30	RS691560-3S	RS691560-3A	HPB6915	HEZD6915
	30"	60"	3	60	RS693060-3S	RS693060-3A	HPB6930	HEZD6930
42"	15"	84"	4	24	RS421584-4S	RS421584-4A	HPB4215	HEZD4215
	30"	84"	4	48	RS423084-4S	RS423084-4A	HPB4230	HEZD4230
69"	15"	84"	4	40	RS691584-4S	RS691584-4A	HPB6915	HEZD6915
	30"	84"	4	80	RS693084-4S	RS693084-4A	HPB6930	HEZD6930
42"	15"	108"	5	30	RS4215108-5S	RS4215108-5A	HPB4215	HEZD4215
	30"	108"	5	60	RS4230108-5S	RS4230108-5A	HPB4230	HEZD4230
69"	15"	108"	5	50	RS6915108-5S	RS6915108-5A	HPB6915	HEZD6915
	30"	108"	5	100	RS6930108-5S	RS6930108-5A	HPB6930	HEZD6930

Be sure to order one each of particle board or EZ-Deck steel decking per level.
The above units do not include record storage boxes.

**Access Unit From
Front or Back!**



Record Storage Unit with 4 levels
(80 Box unit)



729 TAN

PARTICLE BOARD, WIRE DECK & E-Z DECK CAPACITY RATINGS

Recommended safe use load table for 5/8" particle board and EZ-Deck steel decking allowable uniformly distributed static live loads for deck material

Size (inches) W x D	Particle Board Decking	EZ-Deck Steel Decking	2 SIDES SUPPORTED		4 SIDES SUPPORTED		4 SIDES + CENTER SUPPORTED		4 SIDES + 2 CENTER SUPPORTED	
			LOAD (lbs.)	DEFL (ins)	LOAD (lbs.)	DEFL (ins)	LOAD (lbs.)	DEFL (ins)	LOAD (lbs.)	DEFL (ins)
36x12	HPB3612	HEZD3612	425	0.06	675	0.08				
36x18	HPB3618	HEZD3618	400	0.17	550	0.18				
36x24	HPB3624	HEZD3624	305	0.30	435	0.23				
36x30	HPB3630	HEZD3630	250	0.47	385	0.32				
36x36	HPB3636	HEZD3636	150	0.50	180	0.39				
42x12	HPB4212	HEZD4212	490	0.06	755	0.08				
42x18	HPB4218	HEZD4218	460	0.17	600	0.18				
42x24	HPB4224	HEZD4224	355	0.30	500	0.29				
42x30	HPB4230	HEZD4230	300	0.47	410	0.36				
42x36	HPB4236	HEZD4236	175	0.50	385	0.45				
48x12	HPB4812	HEZD4812	560	0.06	850	0.08	1160	0.08		
48x18	HPB4818	HEZD4818	525	0.17	635	0.18	770	0.10		
48x24	HPB4824	HEZD4824	405	0.30	530	0.30	700	0.11		
48x30	HPB4830	HEZD4830	325	0.47	440	0.40	705	0.12		
48x36	HPB4836	HEZD4836	200	0.50	400	0.50	755	0.12		
48x48	HPB4848	HEZD4848	85	0.50	275	0.50	920	0.13		
60x18	HPB6018	HEZD6018	660	0.17	735	0.18	835	0.12	1140	0.08
60x24	HPB6024	HEZD6024	505	0.30	615	0.32	700	0.15	1180	0.10
60x30	HPB6030	HEZD6030	410	0.47	520	0.46	650	0.16	1324	0.11
60x36	HPB6036	HEZD6036	250	0.50	380	0.50	665	0.17	1520	0.12
60x48	HPB6048	HEZD6048	105	0.50	230	0.50	750	0.18	2000	0.14
69x15	HPB6915	HEZD6915	900	0.11	950	0.12	1150	0.12	1250	0.11
69x30	HPB6930	HEZD6930	470	0.50	600	0.50	670	0.20	1220	0.13
72x18	HPB7218	HEZD7218	800	0.17	850	0.17	1000	0.15	1200	0.10
72x24	HPB7224	HEZD7224	605	0.30	680	0.31	770	0.19	1135	0.12
72x30	HPB7230	HEZD7230	500	0.47	610	0.50	680	0.21	1200	0.14
72x36	HPB7236	HEZD7236	300	0.50	390	0.50	655	0.23	1325	0.16
72x48	HPB7248	HEZD7248	130	0.50	215	0.50	685	0.25	1670	0.18
84x24	HPB8424	HEZD8424	705	0.30	765	0.31	870	0.23	1150	0.15
84x30	HPB8430	HEZD8430	570	0.47	650	0.49	735	0.27	1150	0.18
84x36	HPB8436	HEZD8436	355	0.50	415	0.50	670	0.29	1210	0.20
84x48	HPB8448	HEZD8448	150	0.50	215	0.50	660	0.33	1460	0.23
96x18	HPB9618	HEZD9618	1050	0.17	1115	0.17	1300	0.18	1500	0.15
96x24	HPB9624	HEZD9624	810	0.30	850	0.31	1000	0.26	1200	0.18
96x30	HPB9630	HEZD9630	655	0.47	710	0.49	800	0.32	1180	0.20
96x36	HPB9636	HEZD9636	405	0.50	450	0.50	710	0.36	1150	0.24
96x48	HPB9648	HEZD9648	170	0.50	200	0.50	650	0.41	1325	0.28

Wire Decking	Size (inches) W x D	Wire Supports	Capacity (lbs)
HWD3618	36" x 18"	4	725
HWD3624	36" x 24"	4	605
HWD3630	36" x 30"	4	485
HWD3636	36" x 36"	4	455
HWD3648	36" x 48"	4	300
HWD4818	48" x 18"	5	725
HWD4824	48" x 24"	5	605
HWD4830	48" x 30"	5	485
HWD4836	48" x 36"	5	455
HWD4848	48" x 48"	5	300
HWD6018	60" x 18"	6	725
HWD6024	60" x 24"	6	605
HWD6030	60" x 30"	6	485
HWD6036	60" x 36"	6	455
HWD6048	60" x 48"	6	300

All wire decks are powder coated gray.

All sizes measure 1/8" short of nominal dimension in both directions.

NOTE: The above load chart refers to the deck materials only. Particle board decking is 5/8" industrial grade type 1-M-2.

EZ-Deck steel decking is 22 gauge galvanized sheet steel fabricated in 6" deep channel planks (models listed above include multiple planks to meet unit depth). 15" deep Ez-Deck will be shipped in two (2) 7 1/2" deep planks. The allowable shelf load capacity may be reduced due to allowable post and / or beam capacities. Specific deflection limits may also reduce the shelf load capacity.

NOTE: EZ-Deck must be center supported on units 48" wide and wider. EZ-Deck steel decking can NOT be used on single rivet units.

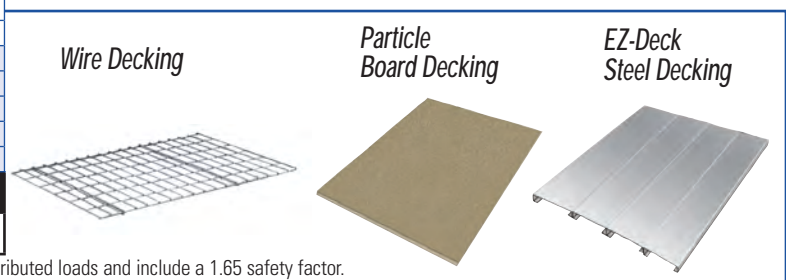

Capacities are based on evenly distributed loads and include a 1.65 safety factor.

TIRE STORAGE RACKS

Width	Depth	Height	Levels	*Tire Capacity	Starter Model No.	Adder Model No.
SINGLE ROW						
60"	21"	84"	3	24	TSS602184-3S	TSS602184-3A
	21"	120"	4	32	TSS6021120-4S	TSS6021120-4A
	21"	144"	5	40	TSS6021144-5S	TSS6021144-5A
DOUBLE ROW						
60"	21"	84"	3	48	TSD602184-3S	TSD602184-3A
	21"	120"	4	64	TSD6021120-4S	TSD6021120-4A
	21"	144"	5	80	TSD6021144-5S	TSD6021144-5A

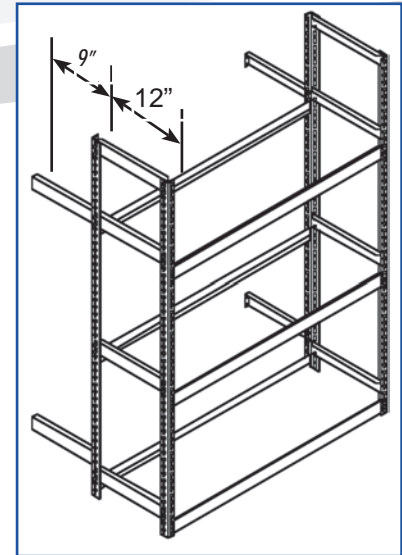

Tire Storage Rack

(*Based on average passenger tire (** Supplied with heavy-duty posts

NOTE: 144" high units are supplied with two 6' posts spliced to achieve 12' height. 192" high units are supplied with two 8' posts spliced to achieve 16' height. For additional configurations, please contact our inside sales department.

MUFFLER STORAGE UNITS

Width	Depth	Height	Levels	Starter Model No.	Adder Model No.	Particle Board Decking	
						Size	Part No.
48"	36"	84"	5	MS483684-5S	MS483684-5A	48" X 36"	HPB4836
96"	36"	84"	5	MS963684-5S	MS963684-5A	96" X 36"	HPB9636

Be sure to order one each of particle board decking per level.

HANGING TAILPIPE RACK

Width	Depth	Height	Starter Model No.
48"	18"	120"	HTP4818120
96"	18"	120"	HTP9618120



Hanging Tailpipe Rack



Tire Rack



729
TAN (PT)



Muffer Storage Rack

COMMERCIAL KD CABINETS

**400
SERIES**

2 YEAR WARRANTY **KD KNOCK DOWN ASSEMBLY**

Functional • Durable • Adaptable

CONFIGURATIONS:

- **Storage** includes 4 adjustable shelves
- **Wardrobe** includes 1 shelf and coat rod
- **Combination** includes 1 full width shelf, 3 half width shelves, and a half width coat rod

24" Deep Storage Cabinets are available in stationary and mobile versions.

DOOR OPTIONS:

- **Solid**
- **Safety-View** (includes polycarbonate panels in door)



GENERAL SPECIFICATIONS

- All components precision engineered with no bolt heads showing on front and side panels
- Body and shelves fabricated from 22 gauge steel
- Shelves easily adjust up or down in 2" increments. Triple flanged shelf front for added strength (capacity up to 200 lbs)
- Reinforced doors swing a full 180°
- 22 gauge steel Doors are factory-hung in 16 gauge frames ensuring proper performance
- 16 gauge continuous hinges
- Corner foot gussets provide added rigidity and stability (replaced by mounting plates on mobile units)
- Positive three-point locking (top, center and bottom) for secure locking
- Plated locking handle has built-in cylinder key lock (keys included)
- Mobile units include four heavy-duty locking swivel casters



BLACK



**DARK GRAY
SAFETY-VIEW DOORS**



TAN



708
BLACK
(ME)

725
DARK GRAY
(HG)

729
TAN
(PT)

**FOR MORE INFO GO TO
LISTINDUSTRIES.COM**

400 SERIES COMMERCIAL KD CABINETS



MOBILE STORAGE



STATIONARY WARDROBE



STATIONARY COMBINATION

Description	Width	Depth	Height	Knock-Down Cat No.	Assembled Cat No.	Colors Standard Finish
SOLID DOOR CABINETS, 400 SERIES						
Stationary, Storage	36	18	72	415S18	415S18A	ME, HG, PT
Stationary, Storage	36	24	72	415S24	415S24A	ME, HG, PT
Stationary, Storage	48	18	72	425S18	425S18A	ME, HG
Stationary, Storage	48	24	72	425S24	425S24A	ME, HG, PT
Stationary, Wardrobe	36	18	72	435W18	435W18A	ME, HG, PT
Stationary, Wardrobe	36	24	72	435W24	435W24A	ME, HG, PT
Stationary, Wardrobe	48	18	72	445W18	445W18A	ME, HG
Stationary, Wardrobe	48	24	72	445W24	445W24A	ME, HG, PT
Stationary, Combination	36	18	72	455C18	455C18A	ME, HG, PT
Stationary, Combination	36	24	72	455C24	455C24A	ME, HG, PT
Stationary, Combination	48	18	72	465C18	465C18A	ME, HG
Stationary, Combination	48	24	72	465C24	465C24A	ME, HG, PT
Mobile, Storage	36	24	72	415S24M	415S24MA	ME, HG, PT
Mobile, Storage	48	24	72	425S24M	425S24MA	ME, HG, PT
SAFETY VIEW DOOR CABINETS, 400 SERIES						
Stationary, Storage	36	18	72	415S18SV	415S18SVA	ME, HG
Stationary, Storage	36	24	72	415S24SV	415S24SVA	ME
Stationary, Wardrobe	36	18	72	435W18SV	435W18SVA	ME, HG
Stationary, Wardrobe	36	24	72	435W24SV	435W24SVA	ME
Stationary, Combination	36	18	72	455C18SV	455C18SVA	ME, HG
Stationary, Combination	36	24	72	455C24SV	455C24SVA	ME
Mobile, Storage	36	24	72	415S24SVM	415S24SVMA	ME

INDUSTRIAL KD CABINETS

**800
SERIES**

2 YEAR WARRANTY **KD KNOCK DOWN ASSEMBLY**

Industrial Strength Storage

Provides maximum protection to tools, dies, delicate instruments, supplies, and personal belongings. Designed to meet government requirements.

CONFIGURATIONS:

- **Storage** includes 4 adjustable shelves
- **Wardrobe** includes 1 shelf and coat rod
- **Combination** includes 1 full width shelf, 3 half width shelves, and a half width coat rod

24" Deep Storage Cabinets are available in stationary and mobile versions.



GENERAL SPECIFICATIONS

- All components precision engineered with no bolt heads showing on front and side panels
- 20 gauge body with 22 gauge shelves provide strength and durability
- Shelves easily adjust up or down in 2" increments. Triple flanged shelf front for added strength (capacity up to 250 lbs).
- Reinforced doors swing a full 180°
- 20 gauge solid steel doors are factory-hung in 16 gauge frames ensuring proper performance
- 16 gauge continuous hinges
- Corner foot gussets provide added rigidity and stability (replaced by mounting plates on mobile units)
- Positive three-point locking (top, center and bottom) for secure locking
- Plated locking handle has built-in cylinder key lock (keys included)
- Mobile units include four heavy-duty locking swivel casters



BLACK



TAN



**DARK GRAY
SAFETY-VIEW DOORS**



**LIGHT GRAY
ANTIMICROBIAL**



708
BLACK
(ME)

729
TAN
(PT)

725
DARK GRAY
(HG)

711
LIGHT GRAY
ANTIMICROBIAL
(PL-AM)

Order your cabinets in our specially formulated Light Gray Antimicrobial powder coat finish that protects against bacteria, mold & yeast for up to 20 years!

800 SERIES INDUSTRIAL KD CABINETS



STATIONARY STORAGE

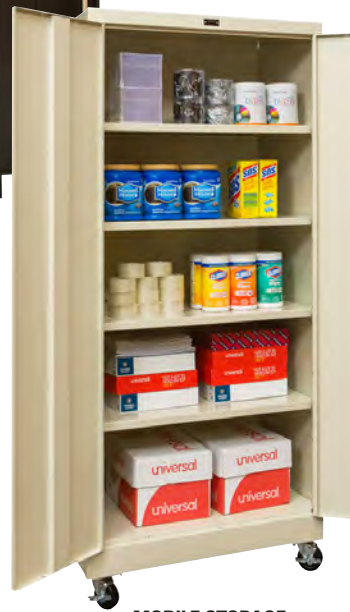

MOBILE STORAGE



STATIONARY WARDROBE



STATIONARY COMBINATION

Description	Width	Depth	Height	Knock-Down Cat No.	Assembled Cat No.	Colors Standard Finish	MedSoFe Light Gray Antimicrobial Finish
SOLID DOOR CABINETS, 800 SERIES							
Stationary, Storage	36	18	78	815S18	815S18A	ME, PT, HG	PL-AM
Stationary, Storage	36	24	78	815S24	815S24A	ME, PT, HG	
Stationary, Storage	48	18	78	825S18	825S18A	ME	
Stationary, Storage	48	24	78	825S24	825S24A	ME, PT	
Stationary, Wardrobe	36	18	78	835W18	835W18A	ME, PT, HG	PL-AM
Stationary, Wardrobe	36	24	78	835W24	835W24A	ME, PT, HG	
Stationary, Wardrobe	48	18	78	845W18	845W18A	ME	
Stationary, Wardrobe	48	24	78	845W24	845W24A	ME, PT	
Stationary, Combination	36	18	78	855C18	855C18A	ME, PT, HG	PL-AM
Stationary, Combination	36	24	78	855C24	855C24A	ME, PT, HG	
Stationary, Combination	48	18	78	865C18	865C18A	ME	
Stationary, Combination	48	24	78	865C24	865C24A	ME, PT	
Mobile, Storage	36	24	78	815S24M	815S24MA	ME, PT, HG	
Mobile, Storage	48	24	78	825S24M	825S24MA	ME, PT	

FOR MORE INFO GO TO
LISTINDUSTRIES.COM

CLASSIC AND GALVANITE™ SERIES ALL-WELDED CABINETS

DURATOUGH™

For Really Tough Industrial Applications

KD KNOCK DOWN ASSEMBLY



Storage Cabinet

16 gauge Classic & Galvanite™
14 gauge Classic & Galvanite™
12 gauge Classic & Galvanite™

Combination Cabinet

16 gauge Classic & Galvanite™
14 gauge Classic & Galvanite™
12 gauge Classic & Galvanite™

GENERAL SPECIFICATIONS

CLASSIC SERIES CABINETS are fabricated from prime grade cold rolled sheet steel.

GALVANITE SERIES CABINETS are fabricated from galvanized sheet steel which has a zinc-iron alloy coating that is applied at the mill providing protection against high-humidity and moist environments. This coating also prevents corrosion from spreading when the paint and/or coating is scratched away.

HEAVY-DUTY CABINETS are 16 gauge with 16 gauge shelves

EXTRA HEAVY-DUTY CABINETS are 14 gauge with 14 gauge shelves

SUPER-DUTY CABINETS are 12 gauge with 14 gauge shelves

SAFETY-VIEW® SERIES CABINETS incorporate polycarbonate panels in both doors of our extra heavy-duty 14 gauge Classic Series cabinets allowing contents to be visible without compromising security.

VENTILATED SERIES CABINETS are fabricated to the same rugged standards as our extra heavy-duty 14 gauge Classic Series cabinets with the added benefit of being fully ventilated with diamond perforated doors and sides and a 13 gauge flattened expanded metal back.

STOCK COLOR

738
CHARCOAL
(CL)

QUICKSHIP

CLASSIC AND GALVANITE™ SERIES ALL-WELDED CABINETS

DURATOUGH™

All the rugged standard features of our popular Classic Series DuraTough cabinets with the added strength and security of 12 gauge sides and doors.



18-gauge full-height door stiffener provides maximum rigidity to both doors



Heavy-Duty 3/16" thick steel handle with padlock hasp

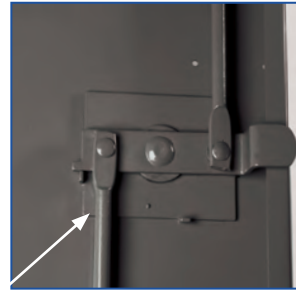

1/8" thick latch and 3/8" diameter lock rods insure maximum security



Safety-View Cabinet
14 gauge Classic



Ventilated Cabinet
14 gauge Classic



STANDARD FEATURES FOR ALL DURATOUGH™ CLASSIC AND GALVANITE™ SERIES CABINETS

- All-welded construction
- Double door design
- Solid doors are reinforced with an 18 gauge full-height door stiffener providing a rigid torque-free door.
- 3-point turn handle locking using 3/8" diameter locking rods operated by a 3/16" gauge steel handle. Handle is painted to match cabinet.
- Heavy-duty 13 gauge 7-knuckle 3-1/2" butt hinges welded to door and securely riveted to frame.
- Solid sides are formed to be integral with vertical door frame.
- Top is formed to be integral with horizontal top door frame.
- Bottom is formed to be integral with horizontal bottom door frame and includes double return bends at all four sides maximizing unit rigidity.

- Back is welded to cabinet top, bottom and sides
- Shelves are formed to provide maximum capacity and are adjustable on 3" centers. Shelves bolt to shelf support channels which are welded to sides.
- 78" high storage cabinets include 4-adjustable shelves
- 60" high storage cabinets include 3-adjustable shelves
- 42" high storage cabinets include 2-adjustable shelves
- 78" high combination cabinets include one full-width upper shelf, a center partition, 3 partial-width shelves and one partial-width coat rod
- Optional leg kits are available and can be bolted on to all DuraTough cabinets.
- Color: 738 Charcoal

CLASSIC AND GALVANITE™ ALL-WELDED CABINETS



DURATOUGH™ CLASSIC SERIES					
Catalog Number	Type	Width (In)	Depth (In)	Height (In)	No. of Shelves
16 GAUGE HEAVY-DUTY					
HW6SC6142-2	Storage	36	21	42	2
HW6SC6160-3	Storage	36	21	60	3
HW6SC6178-4	Storage	36	21	78	4
HW6SC6478-4	Storage	36	24	78	4
HW6SC8460-3	Storage	48	24	60	3
HW6SC8478-4	Storage	48	24	78	4
HW6SC0478-4	Storage	60	24	78	4
HW6CC6478-4	Combination	36	24	78	4
HW6CC8478-4	Combination	48	24	78	4
HW6CC0478-4	Combination	60	24	78	4
14 GAUGE EXTRA HEAVY-DUTY					
HW4SC6142-2	Storage	36	21	42	2
HW4SC6160-3	Storage	36	21	60	3
HW4SC6178-4	Storage	36	21	78	4
HW4SC6478-4	Storage	36	24	78	4
HW4SC8460-3	Storage	48	24	60	3
HW4SC8478-4	Storage	48	24	78	4
HW4SC0478-4	Storage	60	24	78	4
HW4CC6478-4	Combination	36	24	78	4
HW4CC8478-4	Combination	48	24	78	4
HW4CC0478-4	Combination	60	24	78	4
14 GAUGE VENTILATED					
HW4VSC6478-4	Storage	36	24	78	4
HW4VSC8478-4	Storage	48	24	78	4
14 GAUGE SAFETY-VIEW®					
HW4SVSC6478-4	Storage	36	24	78	4
HW4SVSC8478-4	Storage	48	24	78	4
12 GAUGE SUPER-DUTY					
HW2SC6478-4	Storage	36	24	78	4
HW2SC8478-4	Storage	48	24	78	4
HW2SC0478-4	Storage	60	24	78	4
HW2CC6478-4	Combination	36	24	78	4
HW2CC8478-4	Combination	48	24	78	4
HW2CC0478-4	Combination	60	24	78	4

DURATOUGH™ GALVANITE SERIES					
Catalog Number	Type	Width (In)	Depth (In)	Height (In)	No. of Shelves
HEAVY-DUTY-16 GAUGE					
HWG6SC6142-2	Storage	36	21	42	2
HWG6SC6160-3	Storage	36	21	60	3
HWG6SC6178-4	Storage	36	21	78	4
HWG6SC6478-4	Storage	36	24	78	4
HWG6SC8460-3	Storage	48	24	60	3
HWG6SC8478-4	Storage	48	24	78	4
HWG6SC0478-4	Storage	60	24	78	4
HWG6CC6478-4	Combination	36	24	78	4
HWG6CC8478-4	Combination	48	24	78	4
HWG6CC0478-4	Combination	60	24	78	4
EXTRA HEAVY-DUTY-14 GAUGE					
HWG4SC6142-2	Storage	36	21	42	2
HWG4SC6160-3	Storage	36	21	60	3
HWG4SC6178-4	Storage	36	21	78	4
HWG4SC6478-4	Storage	36	24	78	4
HWG4SC8460-3	Storage	48	24	60	3
HWG4SC8478-4	Storage	48	24	78	4
HWG4SC0478-4	Storage	60	24	78	4
HWG4CC6478-4	Combination	36	24	78	4
HWG4CC8478-4	Combination	48	24	78	4
HWG4CC0478-4	Combination	60	24	78	4



738
CHARCOAL
(CL)



SUPER-DUTY 12 GAUGE ALL-WELDED CABINETS

DURATOUGH™ CABINET LEG KITS

Catalog Number	Type	Width (In)	Depth (In)	Height (In)	Legs Per Kit
HWC4LK-1G-HG	Leg Kit	4	21	4	2
HWC4LK-4G-HG	Leg Kit	4	24	4	2

Leg kits can be added to any Hallowell DuraTough Cabinet. Legs are fabricated from galvalume corrosion resistant steel and are easily bolted to cabinet bottom. Includes hardware for field attachment.



DURATOUGH™ CABINET DRAWERS

Catalog Number	Type	Width (In)	Depth (In)	Drawer Height
FKSCD36-2CL	2 Drawer	36	24	7.5
FKSCD48-2CL	2 Drawer	48	24	7.5
FKSCD36-3CL	3 Drawer	36	24	5
FKSCD48-3CL	3 Drawer	48	24	5

Note: Drawer units should always be installed into the lower portion of the cabinets to insure stability when opening the drawers. *Only one drawer should be opened at a time.*



DURATOUGH™ CLASSIC SERIES - SHELVES

Catalog Number	Type	Width (In)	Depth (In)	Height (In)	No. of Shelves
ADDITIONAL SHELVES, FOR HEAVY-DUTY CABINETS					
HW6SCS61	Shelf	36	21	---	1
HW6SCS64	Shelf	36	24	---	1
HW6SCS84	Shelf	48	24	---	1
ADDITIONAL SHELVES, FOR EXTRA HEAVY-DUTY & SUPER DUTY CABINETS					
HW4SCS61	Shelf	36	21	---	1
HW4SCS64	Shelf	36	24	---	1
HW4SCS84	Shelf	48	24	---	1

DURATOUGH™ GALVANITE SERIES - SHELVES

Catalog Number	Type	Width (In)	Depth (In)	Height (In)	No. of Shelves
ADDITIONAL SHELVES, FOR HEAVY-DUTY CABINETS					
HWG6SCS61	Shelf	36	21	---	1
HWG6SCS64	Shelf	36	24	---	1
HWG6SCS84	Shelf	48	24	---	1
ADDITIONAL SHELVES, FOR EXTRA HEAVY-DUTY & SUPER DUTY CABINETS					
HWG4SCS61	Shelf	36	21	---	1
HWG4SCS64	Shelf	36	24	---	1
HWG4SCS84	Shelf	48	24	---	1



24 Designer Powder Coat Finishes for Metal Lockers

Now Available in Standard , Hammertone and Antimicrobial Finishes



742
Rave Red



721
Relay Red



727
Maroon



708
Black

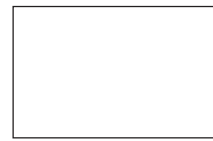

714
Snow White



738
Charcoal



743
Freshwater Blue



731
Denim Blue



720
Pep Rally Purple



710
Sandstone

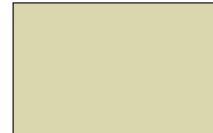

729
Tan

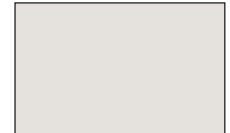

746
Popular Gray



707
Marine Blue



717
Grand Slam Blue



719
Jersey Blue

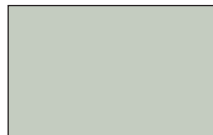

711
Light Gray



706
Heather Gray



725
Dark Gray

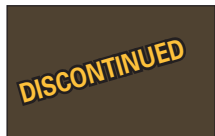

744
Well Bred Brown



745
Deep Forest Brown



704
Evergreen



740
Stardew Gray



741
Rayo de Sol



728
Hoop Orange

NOTE: All body components of production KD lockers will be painted our standard neutral color, currently 729 Tan (choice of 729 Tan or 725 Dark Gray for HDV body).

Enhance your decor with two-tone color combinations, doors one color and frame a second color, **AT NO ADDITIONAL COST.**

LOCKER PREMIUM FINISH OPTIONS (additional charges apply)

HAMMERTONE FINISHES

Specially formulated with a unique hammer texture that is tough, highly durable and provides long lasting protection.

Note: Patterns/colors of textures and metallics will vary due to their nature. No touch up available for hammertone finishes.

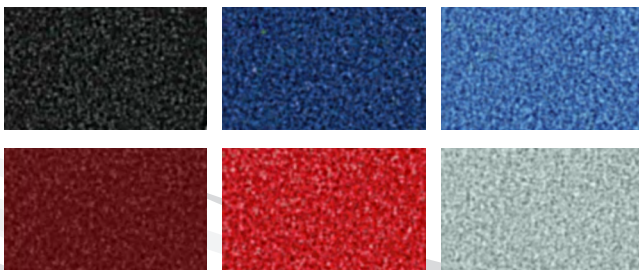

Upgrade available for all 24 standard colors



Upgrade available for all standard 24 colors

Our MedSafe™ antimicrobial finishes with Microban® are specially formulated to protect against bacteria, mold, yeast & mildew for up to 20 years! Very beneficial for educational, healthcare, food processing and other hygiene conscious environments.

Colors shown are an approximate printed representation of the actual color and will vary depending on light source. Actual color samples are available upon request.
List Industries reserves the right to modify its designs and/or make changes in specifications or colors without prior notice.

VersaMax™ lockers use Formica® engineered surfaces, world's largest manufacturer of Phenolic panels

18 DESIGNER COLORS

SOLID COLOR FINISH

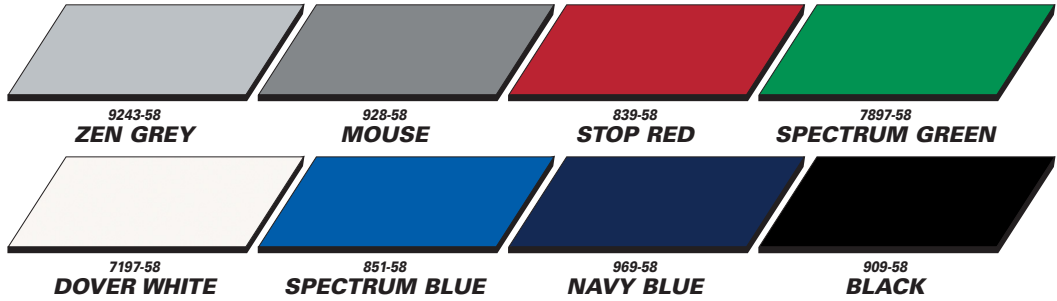

SPECKLE FINISH



WOODGRAIN FINISH

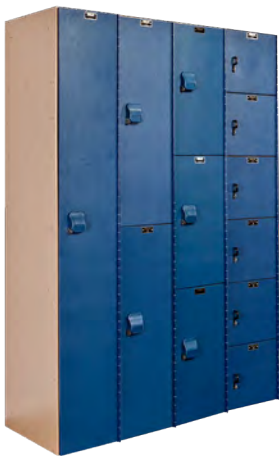
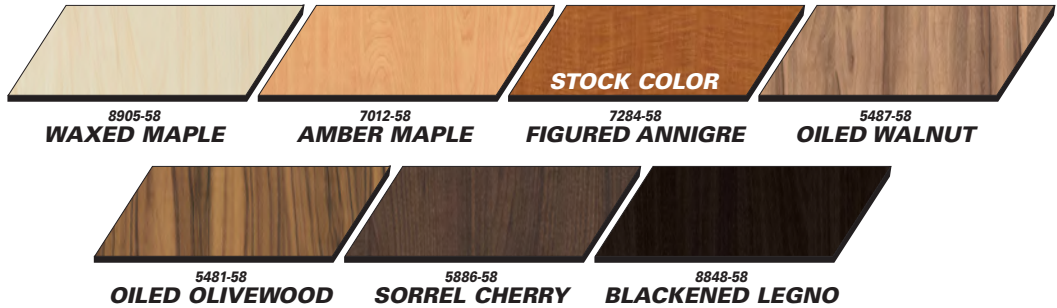

AQUAMAX

HDPE PLASTIC LOCKERS 8 Color Choices



Colors shown are an approximate representation of the actual color. Please do not make your final color selection from printed media or Internet images, as they may not be 100% accurate. For a more accurate color selection call 800-776-1342 or e-mail us at info@ListIndustries.com to request actual color samples.



CLASSIC KD
Wardrobe & Box Lockers



BLACK TIE
Commercial Lockers



STAINLESS STEEL
Wardrobe & Box Lockers



SAFETY-VIEW®
Wardrobe Lockers



SAFETY-VIEW® PLUS
Box Lockers



DIGITECH™ SAFETY-VIEW®
Electronic Box Lockers



MEDSAFE™
Antimicrobial Lockers



READYBUILT™ & READYBUILT™ II
Ready-To-Go Lockers

QUICKSHIP LOCKERS

Ship in **5** Days

Our Quickship stock program is the largest of its kind.

Our unparalleled array of stock lockers guarantees you getting the locker you need, whether it is plastic, wood or metal, box or wardrobe, high performance or emergency response, open-front or high security, we have the right locker for you. Order from stock and save time and money. Our distribution network, comprised of six (6) strategically located, full service, company owned and operated distribution centers, allows us to ship your order fast and secure.

Our products are packaged above industry standards to safeguard your lockers, making sure they arrive in perfect condition.

We have been providing the quality you demand, the timeliness you require and the service you deserve for over 80 years.

To see a complete list of stock lockers, visit our website:

www.ListIndustries.com



CUBIX™
Modular Box Lockers



PE/GYM
All-Welded Ventilated Lockers



MAINTENANCE MAXVIEW™ FREE QUIET™
High Visibility Lockers



SECURITYMAX™
High Security Lockers



CLUB
Prestigious Wood Lockers



HYBRID
Wood & Metal Lockers



TA-50
Ventilated Gear Lockers



RECRUITER™ 2
Open-Front Wood Sport Lockers



TURNOUT GEAR
All-Welded Firefighter Lockers





VALUEMAX™
Economy Lockers



HDV HEAVY-DUTY
Ventilated Lockers



SINGLE-POINT WELDED SPORT
Welded Lockers



Open-Front
Sport/Gear Lockers



GALVANITE™
Corrosion Resistant
Lockers



LAPTOP/BACKPACK
Ventilated Charger
Lockers



CELLPHONE/TABLET
Mobile Device Lockers

QUICK-SHIP BENEFITS

- ✓ No Setup Charges
- ✓ No Minimum Order Quantity
- ✓ Industry's Best Discount

ADVANTAGES OF SIX DISTRIBUTION CENTERS

- ✓ Reduces Freight Cost
- ✓ Reduces Transit Time
- ✓ Minimizes Carrier Handling



KID/TEEN
Home Lockers



HOME TEAM™
Ventilated Home Lockers



UNIFORM EXCHANGE
Garment Lockers

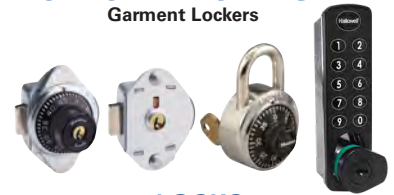

LOCKS
Hallowell Electronic & Master Built-in Combo & Key, Master Padlock

5 Distribution Centers Nationwide

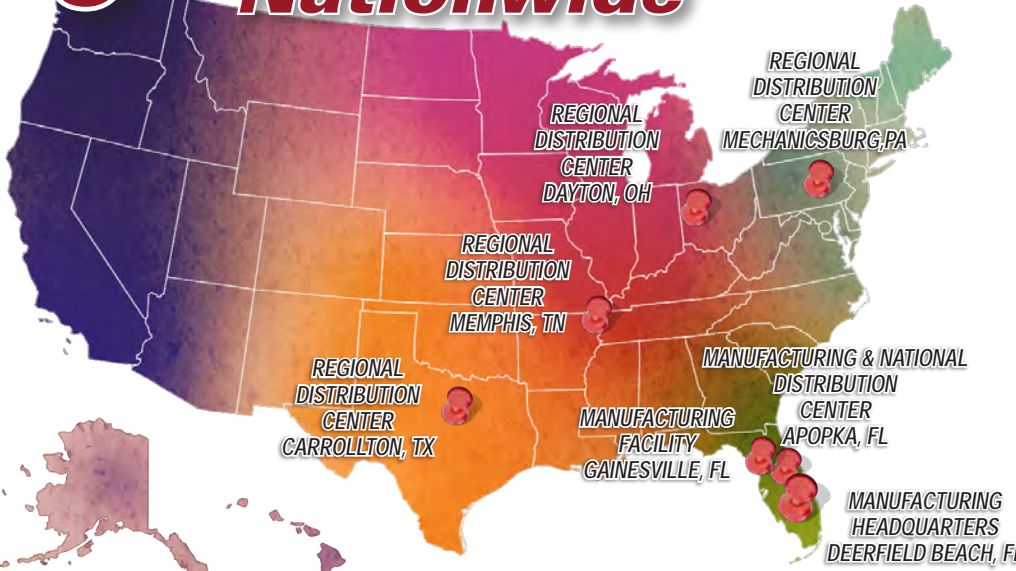

BSL
Bulk Storage
Lockers



TASKFORCE XP™
Emergency Response
Lockers



BENCHES & PEDESTALS
Steel Adjustable, Stainless steel, Cast Iron
Extra Heavy-Duty, Steel, Movable Aluminum



Phenolic Lockers



MEDSAFE™ AQUAMAX™
HDPE Antimicrobial Lockers



AQUAMAX™
HDPE Plastic Lockers

SUPERIOR
AMERICA'S MOST COMPLETE LOCKER LINE

AMERICA'S MOST COMPLETE LOCKER LINE®

SUPERIOR®

FULL LINE CATALOG

1-800-776-1342

ListIndustries.com



401 JIM MORAN BLVD., DEERFIELD BEACH, FL 33442



**Proudly Made in America
Since 1936**